



SwitchBee

A Quick Switch to A Smart Home

SwitchBee

A Quick Switch to A Smart Home

SwitchBee is an innovative company with a game-changing technology that enables you to convert any home into an affordable smart home with a sleek design.

The SwitchBee products are easily and quickly installed, without changing the existing electrical infrastructure or additional preparation, allowing you to convert your home into a smart home in two hours by simply using a screwdriver.

The user-friendly application allows control over lighting, electrical blinds and shutters, the water boiler, and other electrical devices in the home from anywhere and at any time, and to set up scenarios and timers easily and quickly without limits.

Lighting

Electric
Shutters

Water
Heaters

Power
Switches

Gates /
Garages

Air
Conditioners

Televisions

Sound
Systems

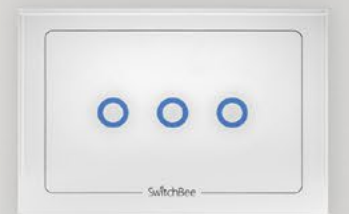

SwitchBee

A Quick Switch to A Smart Home

Decorative Switch Covers Type 55mm European Fit

A clean and fresh range of switches, with touch activation and back light, that are suitable for use in 55mm wall boxes, without the need for a neutral wire or a change in the infrastructure. Using the SwitchBee Application, each module can be set up to work as an On/Off Switch or as a Dimmer Switch or a Two-Way Switch or a Scenario Switch, or a Timed Switch. Timers can be set on all the switches.

Regular Style

Basic Face Plate
1 gang



Basic Face Plate
2 gang



Basic Face Plate
Shutter/Blinds



Basic Face Plate
Power Switch-Time delay



Glass Style

Glass Style Face Plate
1 gang



Glass Style Face Plate
2 gang



Glass Style Face Plate
Shutter/Blinds



Glass Style Face Plate
Water heater/Power Switch-Time delay



Modular SwitchBee System for Existing 50mm European Switch Covers.

This range of SwitchBee modules and adapters is suitable to fit into the homes of existing switch ranges with an interchangeable touch insert. The Switches are backlit and touch enabled.

They are ideal for homes where there is a need to fit SwitchBee into an existing switch design or color that matches existing sockets, switches and other devices.

By using the SwitchBee application, the home owner can simply select how the switch should function: as an On/Off Switch, a Dimmer Switch, a Two-Way Switch, a Scenario Switch or a Timed Switch.

Modular Range for Existing European Switches

Touch Plate
1 gang



Touch Plate
2 gang



Touch Plate
Shutter/Blinds

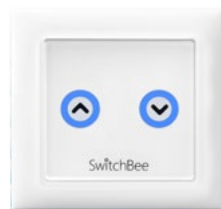

Touch Plate
Power Switch-Time delay

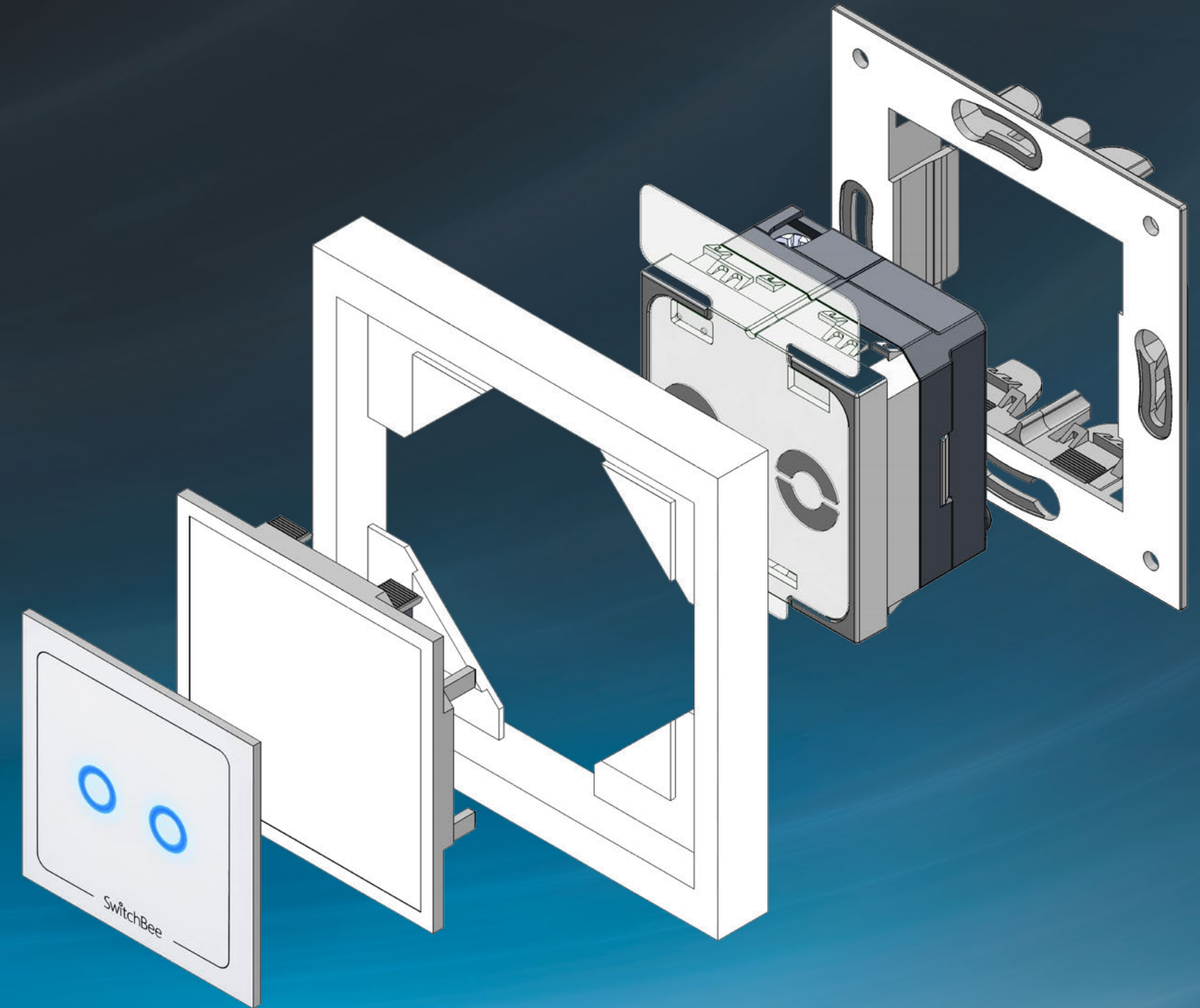

SwitchBee

A Quick Switch to A Smart Home

Decorative Switch Covers Type 87x87 mm - UK fit

This range of switches covers offers a clean and fresh look. Backlit and touch enabled, they are ideal for your new smart home. They are suitable for use in conjunction with a 55mm wall box in single gang, double gang or twin gang.

Suitable for both internal wall boxes and external wall boxes. There is no need for a neutral wire and no need for any extra wiring – just use the existing electrical infrastructure.

By using the SwitchBee application, each switch may be set up as an On/Off Switch, as a Dimmer Switch, as a Two-Way Switch or as a favourite Scenario Switch.

Glass Cover Plate
One Way



Glass Cover Plate
Two Way



Glass Cover Plate
Shutter/Blinds



Glass Cover Plate
Power Switch-Time delay



Single Gang
(87mm x 87mm)

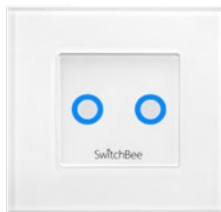

Double Gang
(87mm x 146mm)

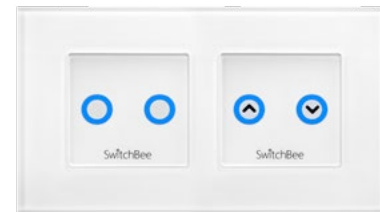

Twin Gang – 2 x Single Gangs
(87mm x 175mm)

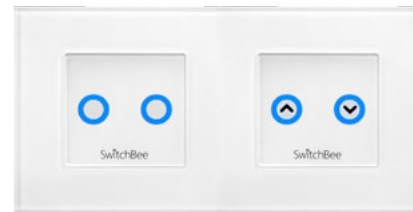

SwitchBee

A Quick Switch to A Smart Home

Modular SwitchBee System for Existing USA Switch Covers.

This range of switches offers a clean and fresh look. Backlit and touch enabled, they are ideal for your new smart home. They are suitable for use in conjunction with a standard USA wall box, and the switch sizes are designed to fit single gang and multi-gang wall plates. There is no need for a neutral wire – just use the existing electrical infrastructure. This type of wall plate together with the smart modules allows a variety of combinations of switches to be used in the same wall box – electric shutters, lights and fans can be combined.

By using the SwitchBee application, each switch may be set up as an On/Off switch, as a Dimmer Switch, as a Two-Way Switch or as a favourite Scenario Switch.

Touch Plate
1 gang



Touch Plate
2 gang



Touch Plate
Shutter/Blinds



Touch Plate
Power Switch-Time delay



Decorative Switch Covers - Vertical Fit Suitable for South Africa and Australia

Decorative wall switches in a sleek and elegant design that are suitable for rectangular wall boxes without the need for a neutral wire or any changes to the electrical infrastructure. The frames are available in a wide variety of switch combinations, such as lighting, electrical blinds, and power switches.

Clear Glass
Face Plate
1 gang



Clear Glass
Face Plate
2 gang



Clear Glass
Face Plate
3 gang



Clear Glass
Face Plate
Shutter/Blinds



Clear Glass
Face Plate
Water Heater/Time Delay



Decorative Switch Covers – Italian Fit Clear Glass Style for Rectangular boxes

Decorative wall switches in a sleek and elegant design that are suitable for rectangular wall boxes without the need for a neutral wire or any changes to the electrical infrastructure. The frames are available in a wide variety of switch combinations, such as lighting, electrical blinds, and power switches.

Clear Glass Face Plate
1 gang



Clear Glass Face Plate
2 gang



Clear Glass Face Plate
3 gang



Clear Glass Face Plate
4 gang

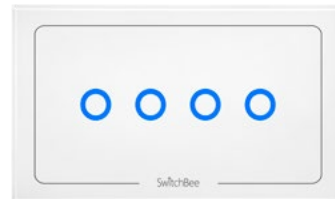

Clear Glass Face Plate
Shutter/Blinds



Clear Glass Face Plate
2 Gang and Shutter/Blinds



Clear Glass Face Plate
2 Shutter/Blinds



Clear Glass Face Plate
Water Heater/Time Delay



Clear Glass Face Plate (Long)
Water Heater/Time Delay

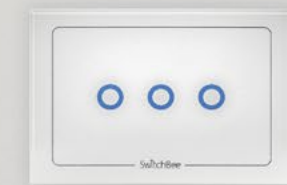

Decorative Switch Covers - Italian Fit Glass Style for Rectangular boxes

Modular wall switches that offer a backlit and touch-enabled switch in an elegant glass design. They are suitable for installation into a rectangular wall box without the need for a neutral wire or any change to the existing infrastructure. The decorative cover plate together with the smart SwitchBee module allows a combination of modular switches, such as lights, electrical blinds and more, to be combined in one switch box.

Glass Face Plate
1 gang

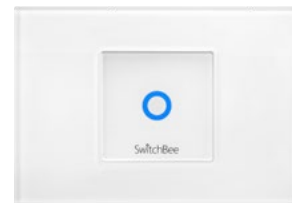

Glass Face Plate
2 gang

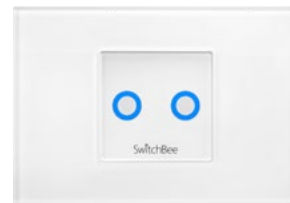

Glass Face Plate
3 gang



Glass Face Plate
4 gang



Glass Face Plate
6 gang



Glass Face Plate
Shutter/Blinds



Glass Face Plate
2 Gang and Shutter/Blinds



Glass Face Plate
2 Shutter/Blinds



Glass Face Plate
Water Heater/Time Delay



Decorative Switch Covers – Italian Fit Basic Style for Rectangular boxes

This range of wall switches is designed to provide a simple and elegant switch which is both backlit and touch enabled. They are suitable for use with rectangular wall boxes without requiring a neutral wire.

The cover plates and SwitchBee modules allow for several combinations of lighting and electrical shutter controls.

Basic Face plate
1 gang



Basic Face plate
2 gang



Basic Face plate
3 gang

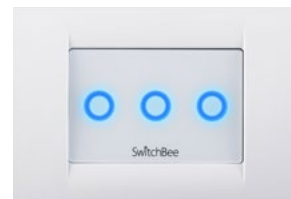

Basic Face plate
4 gang



Basic Face plate
6 gang



Basic Face plate
Water Heater/Time Delay



Basic Face plate
Shutter/Blinds



Basic Face plate
2 Gang and Shutter/Blinds



Basic Face plate
2 Shutter/Blinds



External Wall Switches

This range of wall boxes for installation over the plaster are suitable for use outside in the garden and balcony. Inside these dust proof and water-resistant boxes, the full range of smart SwitchBee modules can be fitted. Enjoy all the benefits of the smart switches for lights, shutters and curtains, patio awnings and more – also outside. The boxes allow for control of one, two or three touch switches.

Over Plaster Box
1 Gang



Over Plaster Box
2 Gang



Over Plaster Box
3 Gang



Over Plaster Box - Irrigation Controller

The irrigation controller allows control of up to 3 faucets. Control and set up timers easily through the application.





Sockets with built-in IR

The SwitchBee socket switches are available for many types of plug sockets and are compatible with all voltages. The lower part of the socket switch can be used to control On/Off switching to devices, or to dim lamps, and will also measure the current consumption of the connected device.

The upper part of the socket switch is an intuitive infrared blaster, that can be taught any type of IR commands and then play them back through the application. Use it to control Air Conditioners, Televisions, Sound Systems and any other device that works with an IR remote control.



The Sticker Switch

The sticker switch can be positioned anywhere in the home. Set it up through the application as a two-way switch or a scenario switch. The sticker switch is designed to be used in areas where there is a need to add a switch, in an area where it is not feasible to add new wiring, or in places where children or people with special needs need to reach the switch. The sticker switch works on batteries that last 3-5 years.



The SwitchBee Modules

One module fits all: All our switch ranges use the same smart modules that do not require a neutral wire (excluding our 16A modules), or new wiring.

Range: SwitchBee has developed advanced technology that allows the modules to have an effective range of up to 100m within built-up brick or concrete environments and which will pass through concrete walls. Outdoors, the range is up to 500m.

Transmission: The length of transmission of each command is less than 2 milliseconds and at a very low power level. Transmissions only occur when a command is initiated.

1 Way Module
(3A)



2 Way Module
(3A)



3 Way Module
(3A)



1 Way Module
(10A)



2 Way Module
(10A)



3 Way Module
(10A)



Power Module



Power/Timed
Module



Shutter/
Blind Module



Double Shutter/
Blind Module



Shutter/Blind
Module with 2 Way

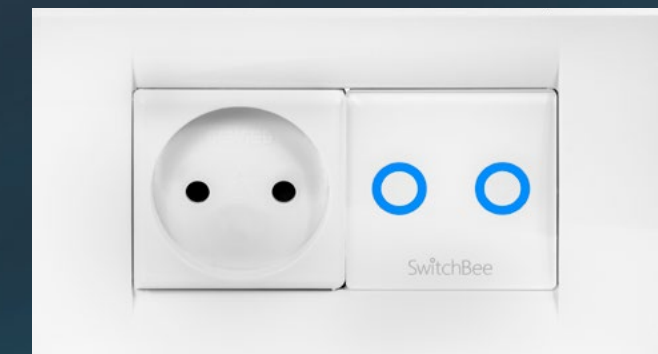

SwitchBee

A Quick Switch to A Smart Home

The Application

To control the smart home, download the SwitchBee application (Available in iOS or Android versions).

After installing the application, connect in a secure way to control the smart home from anywhere and at any time.

Using the SwitchBee application, the switch function can be setup as an On/Off Switch, a Dimmer, a Two-Way Switch, or a Scenario Switch. The electrical shutter switches allow control, by percentages, of opening of the shutters, and the water heater switches or power switches allow setting up of the length of time of operation.

One can setup timers on all the switches and scenarios through the user-friendly application.



The Central Unit

Control: The central unit is the brain of the system and it allows the electricity to be controlled in the home at any time and from any location.

Communication: The central unit works through a system of very short two-directional

RF broadcasts to each of the connected modules that communicate to it. When a command is sent through the application, the mobile phone or tablet transmits this command through the Wi-Fi network or the LTE/3G network to the central unit. It is important to note that even in the event that the central unit stops functioning, all the switches still function as normal, by manually pressing them.

Range: The range of the RF transmissions is up to 100m in built up areas, such as inside the house (including brick walls and reinforced concrete). Outdoors, the range is up to 500m.

Privacy: All the data regarding the name of the switches, room names, users and functionality is stored on the central unit in the home owners home. There is no storage in the cloud. The system also makes automatic daily backups of all the settings.

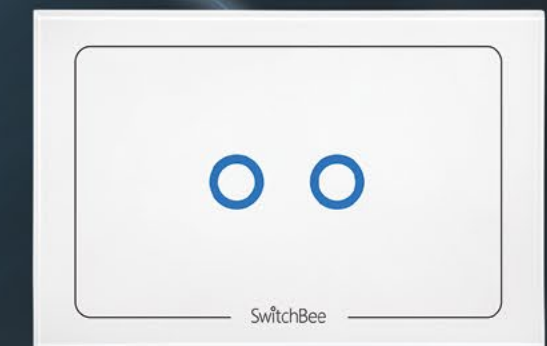

Decorative Switch Covers Type 55mm European Fit - 80x80

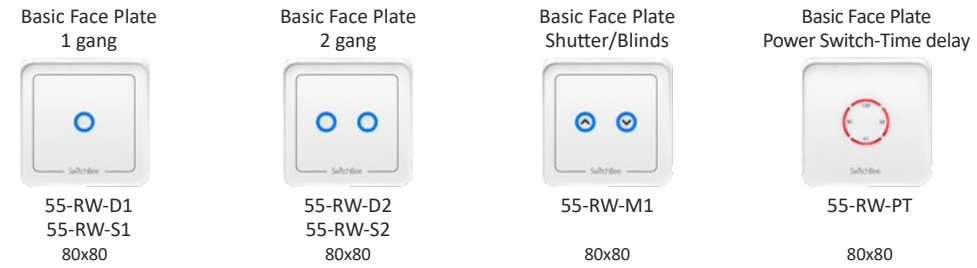

Glass Range



Decorative Switch Covers – Italian Fit – Glass Style for Rectangular boxes

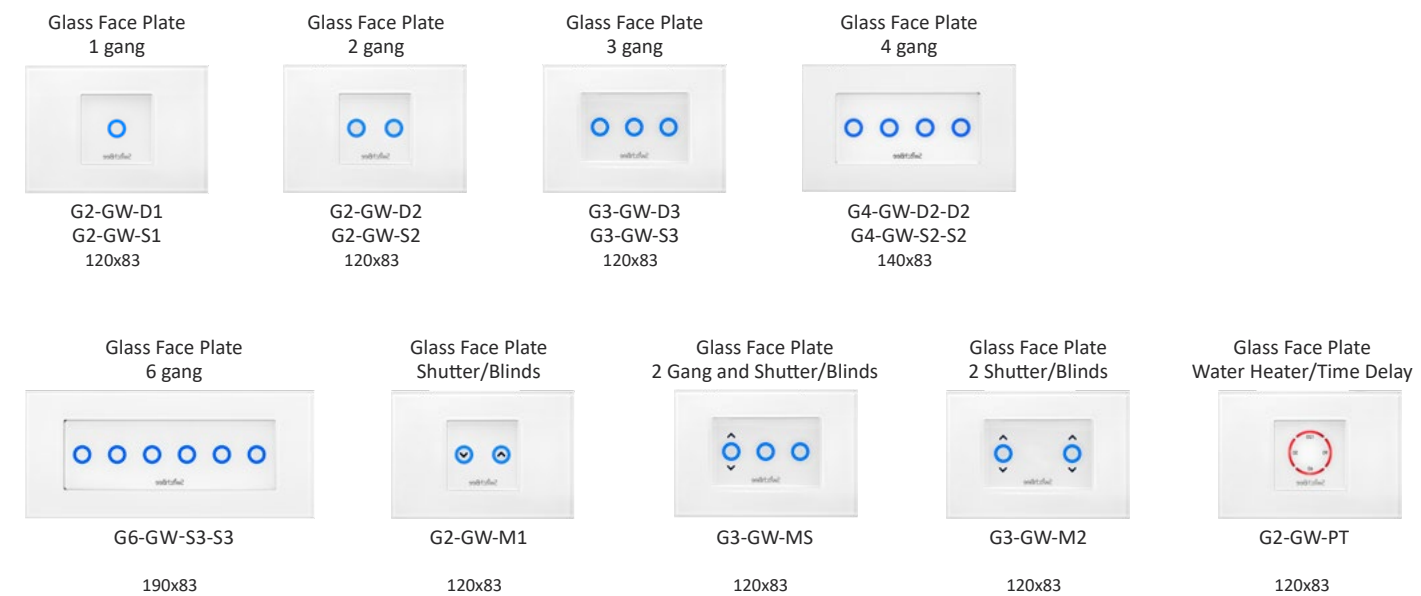

Decorative Switch Covers – Italian Fit - Clear Glass Style for Rectangular boxes

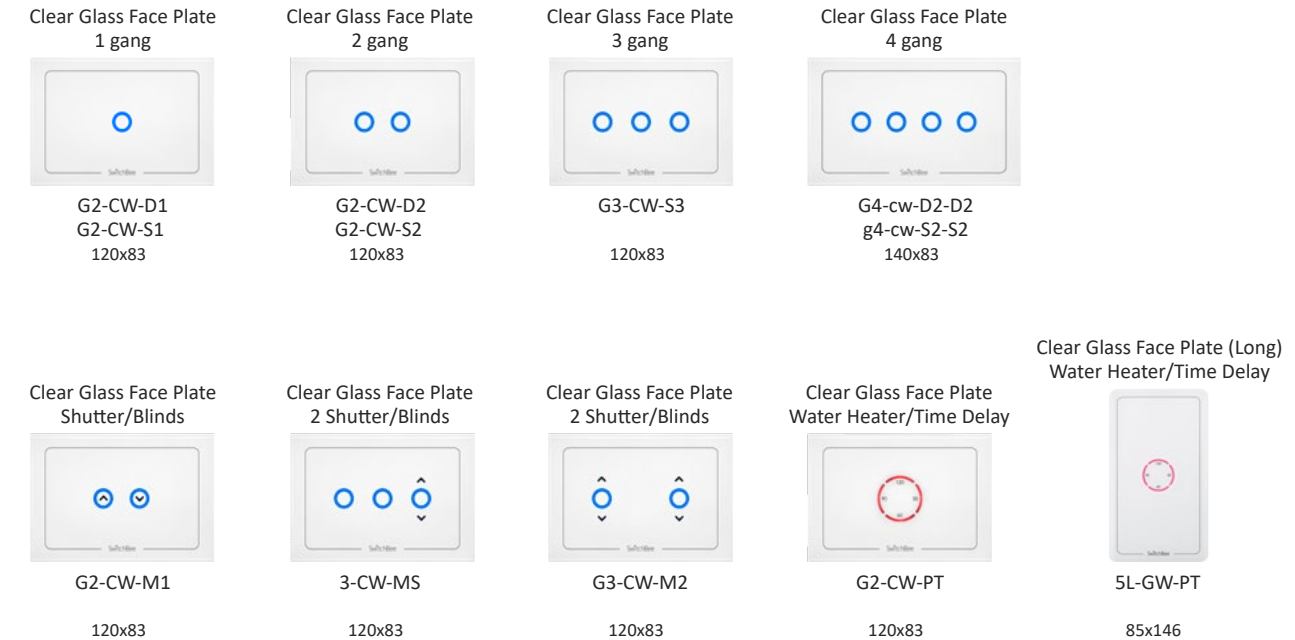

Decorative Switch Covers – Italian Fit - Basic Style for Rectangular boxes

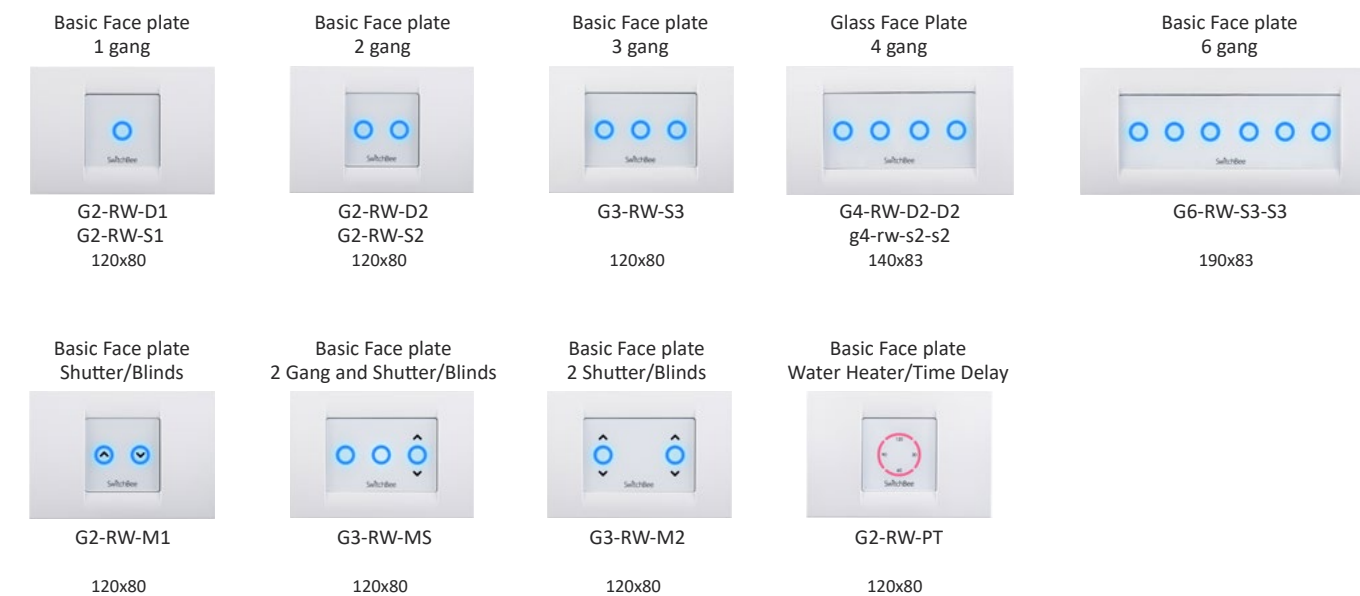

External Wall Switches



The SwitchBee Modules

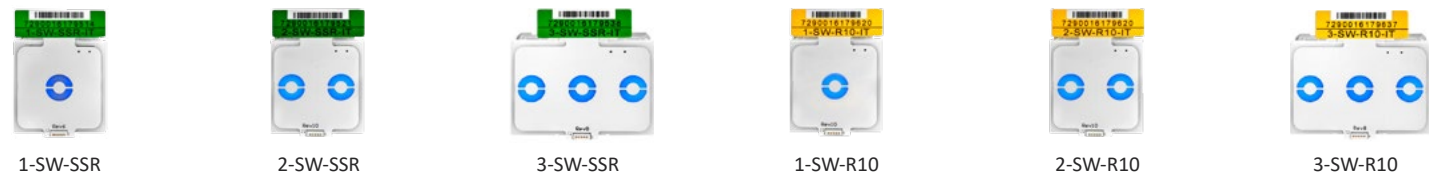

Accessories



THE COMPANY RETAINS THE RIGHT TO UPDATE, FROM TIME TO TIME, AS NECESSARY, THE DESIGN OF THE PRODUCTS

Modular SwitchBee System for Existing 50mm European Switch Covers.

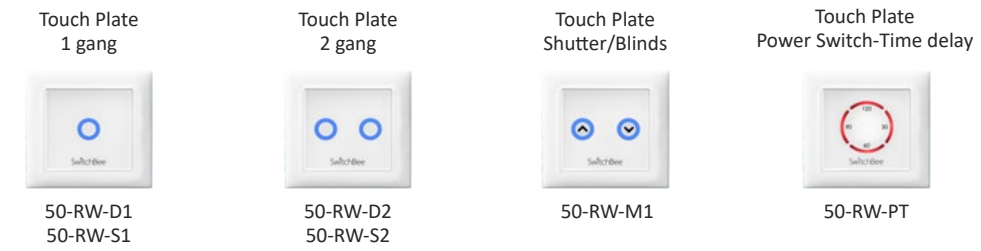

Decorative Switch Covers Type 87x87 mm - UK fit



Modular SwitchBee System for Existing USA Switch Covers.

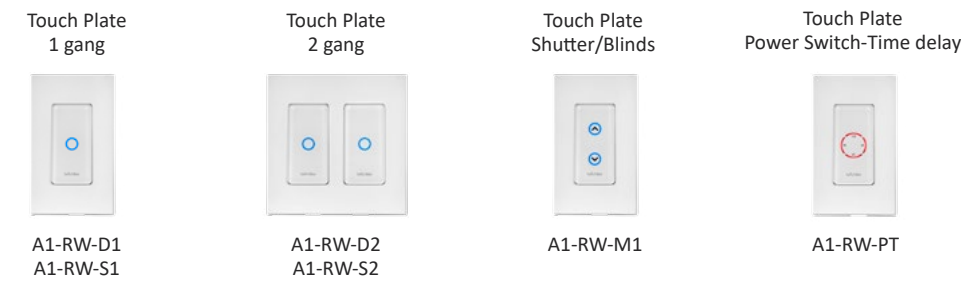

Decorative Switch Covers - Vertical Fit Suitable for South Africa and Australia



THE COMPANY RETAINS THE RIGHT TO UPDATE, FROM TIME TO TIME, AS NECESSARY, THE DESIGN OF THE PRODUCTS

SwitchBee

A Quick Switch to A Smart Home

info@switchbee.com | www.switchbee.com