

ACCESSORIES

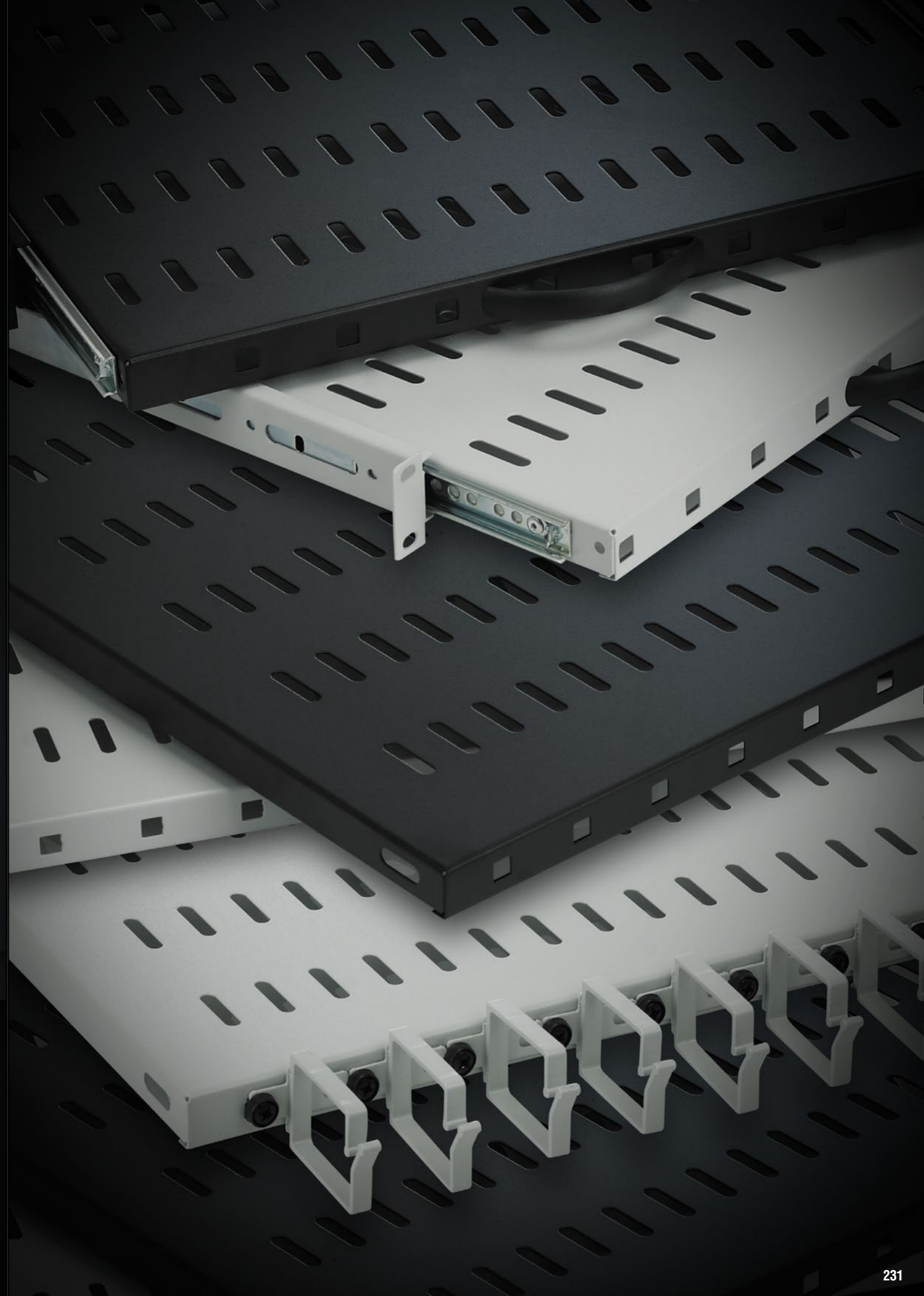

SHELVES

FIXED SHELVES

Loading Capacity : 50kg

Product Code	Product Description	Product Dimensions WxDxH (mm)	Package Dimensions WxDxH (mm)	Product Net Weight (kg)	Product Gross Weight (kg)	Number in the Package (pcs)	Box Dimensions WxDxH (mm)	Box Gross Weight (kg)
MR.SBR60.XX	D=600 Fixed Shelf	465x345x25	480x355x40	1,5	1,8	12	550x430x400	22,5
MR.SBR80.XX	D=800 Fixed Shelf	465x525x25	480x550x40	2,2	2,7	12	550x430x630	34
MR.SBR100.XX	D=1000 Fixed Shelf	465x725x25	480x725x40	2,9	3,2	10	800x430x510	34

Fixed shelves are cabinet shelves adaptable to Mirsan-Rack cabinets, with 4 connection points and bearing ventilation slots thereon.

By attaching single cable organizer to the rectangular openings on the front and back, cables of the devices installed thereon may be organized professionally.

COLOR OPTIONS

RAL 7035 LIGHT GREY RAL 9005 BLACK

XX= Color Code, 02 means Light Grey RAL 7035 and 01 means Black RAL 9005, the code is added by the customer at the order.

SLIDING SHELVES

Loading Capacity : 30kg

Product Code	Product Description	Product Dimensions WxDxH (mm)	Package Dimensions WxDxH (mm)	Product Net Weight (kg)	Product Gross Weight (kg)	Number in the Package (pcs)	Box Dimensions WxDxH (mm)	Box Gross Weight (kg)
MR.HRK60.XX	D=600 Sliding Shelf	482x345x45	510x355x60	2,1	2,4	7	550x430x400	19
MR.HRK80.XX	D=800 Sliding Shelf	482x525x45	510x550x60	3,1	3,4	7	550x430x630	26,5

Sliding shelves are cabinet shelves adaptable to MirsanRack cabinets, with 4 connection points, movable within the depth and bearing ventilation slots thereon.

COLOR OPTIONS

RAL 7035 LIGHT GREY RAL 9005 BLACK

XX= Color Code, 02 means Light Grey RAL 7035 and 01 means Black RAL 9005, the code is added by the customer at the order.

2 POINT CONNECTED RACK MOUNT SHELVES

Loading Capacity : 30kg

Product Code	Product Description	Product Dimensions WxDxH (mm)	Package Dimensions WxDxH (mm)	Product Net Weight (kg)	Product Gross Weight (kg)	Number in the Package (pcs)	Box Dimensions WxDxH (mm)	Box Gross Weight (kg)
MR.RAK1U20.XX	1U 19" D=200mm rack mount shelf	486x200x44	510x240x50	0,9	1,1	10	550x430x400	13
MR.RAK1U25.XX	1U 19" D=250mm rack mount shelf	486x250x44	510x280x50	1,1	1,3	10	550x430x400	15
MR.RAK1U30.XX	1U 19" D=300mm rack mount shelf	486x300x44	505x305x50	1,3	1,6	9	550x430x400	17
MR.RAK1U40.XX	1U 19" D=400mm rack mount shelf	486x400x44	515x415x55	1,7	2,1	8	550x430x400	16,8
MR.RAK2U35.XX	2U 19" D=350mm rack mount shelf	486x350x88	510x360x90	2,1	2,4	4	550x430x400	11
MR.RAK2U55.XX	2U 19" D=550mm rack mount shelf	486x550x88	500x595x100	3,3	3,8	4	550x430x630	16,5

Rack mounts with 2 point connections are cabinet shelves adaptable to all 19" cabinets and bearing ventilation slots thereon.

In case of need 2 side brackets with adjustable depth may be added to the back.

COLOR OPTIONS

RAL 7035 LIGHT GREY RAL 9005 BLACK

XX= Color Code, 02 means Light Grey RAL 7035 and 01 means Black RAL 9005, the code is added by the customer at the order.

4 POINT CONNECTED RACK MOUNT SHELVES

Loading Capacity : 50kg

Product Code	Product Description	Product Dimensions WxDxH (mm)	Package Dimensions WxDxH (mm)	Product Net Weight (kg)	Product Gross Weight (kg)	Number in the Package (pcs)	Box Dimensions WxDxH (mm)	Box Gross Weight (kg)
MR.HRM1U35.XX	1U 19" front, 1U 19" rear connection D=350mm Shelf	486x350x44	510x410x55	2,1	2,4	7	550x430x480	18,9
MR.HRM2U35.XX	2U 19" front, 1U 19" rear connection D=350mm Shelf	486x350x88	510x360x100	2,2	2,6	4	545x425x400	12,3
MR.HRM1U45.XX	1U 19" front, 1U 19" rear connection D=450mm Shelf	486x450x44	558x475x57	2,4	2,7	7	550x450x630	21
MR.HRM2U45.XX	2U 19" front, 1U 19" rear connection D=450mm Shelf	486x450x88	595x500x100	2,7	3,1	4	550x450x630	14,5
MR.HRM2U55.XX	2U 19" front, 1U 19" rear connection D=550mm Shelf	486x550x88	595x500x100	3,3	3,7	4	550x450x630	17
MR.HRM2U65.XX	2U 19" front, 1U 19" rear connection D=650mm Shelf	486x650x88	683x490x90	3,5	4	4	550x440x800	18,5

Rack mounts with 4 point connections in total, as 2 on the front and 2 on the back, are cabinet shelves adaptable to all 19" cabinets and bearing ventilation slots thereon.

By means of 2 depth adjustable side brackets at the back, they may be installed at various depths.

COLOR OPTIONS

RAL 7035 LIGHT GREY RAL 9005 BLACK

XX= Color Code, 02 means Light Grey RAL 7035 and 01 means Black RAL 9005, the code is added by the customer at the order.

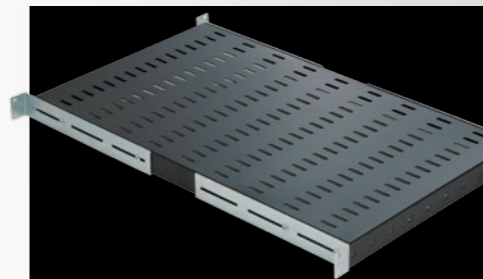
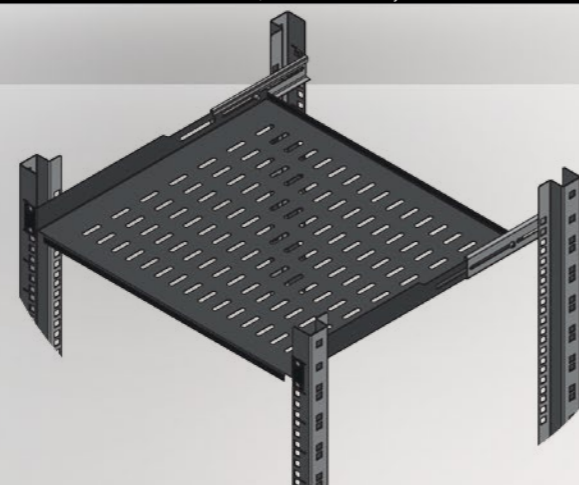
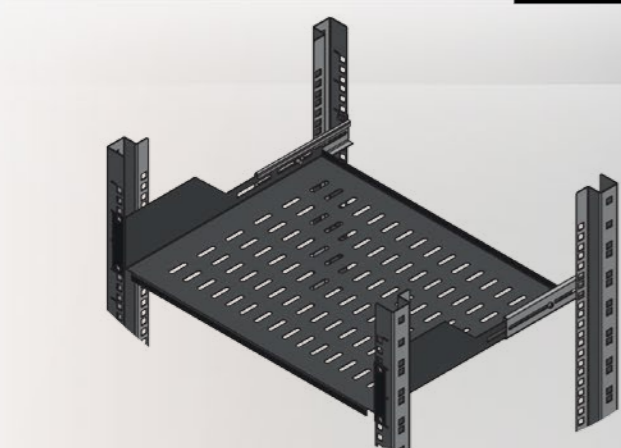
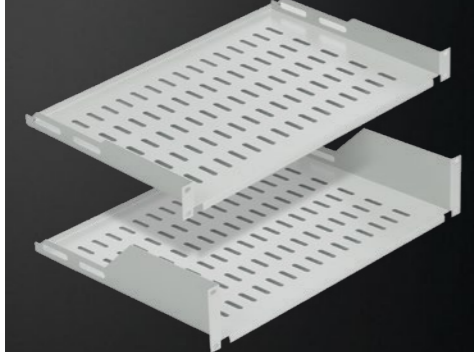
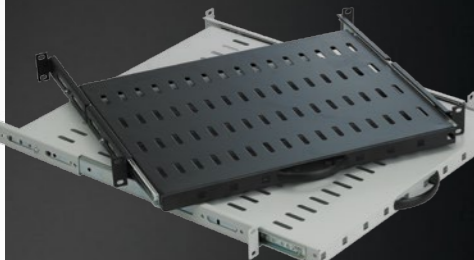
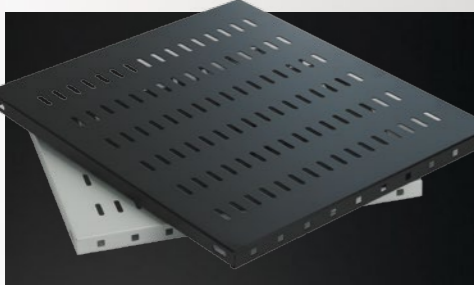

4 POINT CONNECTED HEAVY DUTY TYPE SERVER FIXED SHELVES

Loading Capacity : 100kg

Product Code	Product Description	Product Dimensions WxDxH (mm)	Package Dimensions WxDxH (mm)	Product Net Weight (kg)	Product Gross Weight (kg)	Number in the Package (pcs)	Box Dimensions WxDxH (mm)	Box Gross Weight (kg)
MR.SRS100.XX	Heavy duty type D=1000 Server Fixed Shelf	482x740x45	510x750x60	4,1	4,6	8	550x440x800	41

Heavy duty fixed shelves are server cabinet shelves with high resistance, adaptable to all 19", D=1000 cabinets and bearing ventilation slots thereon.

Thanks to depth adjustable side brackets found at the front and back, they are able to establish connection at 4 points from back and front.

COLOR OPTIONS

RAL 7035 LIGHT GREY RAL 9005 BLACK

XX= Color Code, 02 means Light Grey RAL 7035 and 01 means Black RAL 9005, the code is added by the customer at the order.

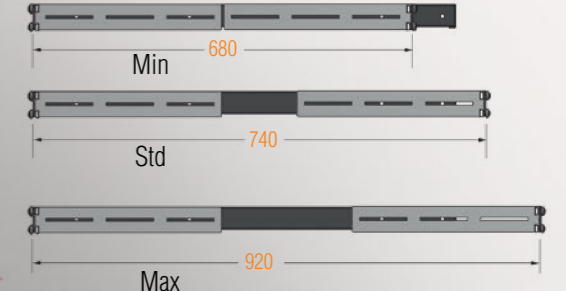
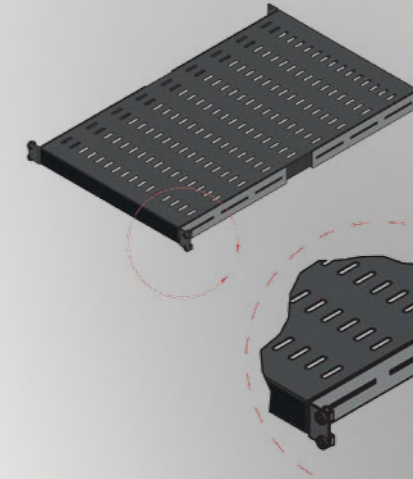

4 POINT CONNECTED HEAVY DUTY TYPE SERVER SLIDING SHELVES

Loading Capacity : 50kg

Product Code	Product Description	Product Dimensions WxDxH (mm)	Package Dimensions WxDxH (mm)	Product Net Weight (kg)	Product Gross Weight (kg)	Number in the Package (pcs)	Box Dimensions WxDxH (mm)	Box Gross Weight (kg)
MR.SRH100.XX	Heavy duty type D=1000 Server Sliding Shelf	482x740x45	510x750x60	6,1	6,7	8	550x440x800	57

Heavy duty movable shelves are server cabinet shelves with high resistance, adaptable to all 19", D=1000 cabinets, movable throughout the depth, and bearing ventilation slots thereon.

Moving mechanism may be locked by means of 2 flap locks introduced on the left and right, when inside the cabinet.

COLOR OPTIONS

RAL 7035 LIGHT GREY RAL 9005 BLACK

Thanks to depth adjustable side brackets found at the front and back, they are able to establish connection at 4 points from back and front.

They are delivered with acrobatic arms at their backs, organizing cabling of the devices.

XX= Color Code, 02 means Light Grey RAL 7035 and 01 means Black RAL 9005, the code is added by the customer at the order.

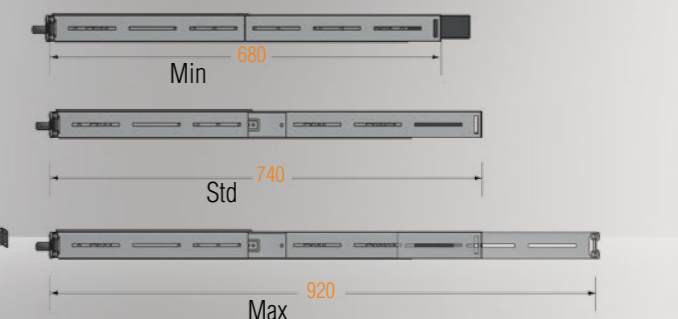
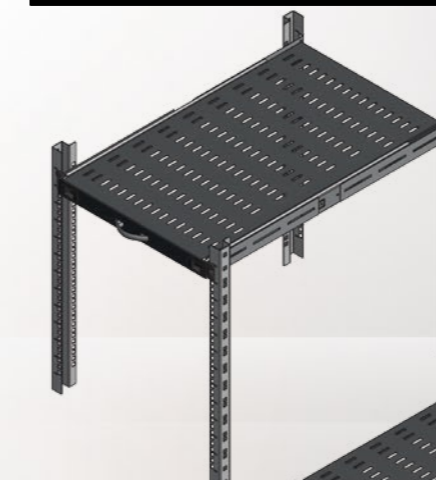

L TYPE SUPPORT MODULES

Loading Capacity : 100kg

Product Code	Product Description	Product Dimensions WxDxH (mm)	Package Dimensions WxDxH (mm)	Product Net Weight (kg)	Product Gross Weight (kg)	Number in the Package (pcs)	Box Dimensions WxDxH (mm)	Box Gross Weight (kg)
MR.LDS60.ZN	D=600 L Type Support Module, galvanized finish, 1set=2pcs.	300x45x45	320x60x60	0,7	1	36	550x430x400	37
MR.LDS80.ZN	D=800 L Type Support Module, galvanized finish, 1set=2pcs.	500x45x45	520x60x60	1,1	1,4	36	550x430x400	51,5
MR.LDS100.ZN	D=1000 L Type Support Module, galvanized finish, 1set=2pcs.	650x45x45	670x60x60	1,3	1,6	36	810x430x525	58,5

They are supporting modules adaptable to 19" cabinets and are used in order to prevent sagging of the rack mounted or unmounted 19" heavy devices.

They are delivered as 1 set: 2 pieces; 1 for connecting on the right and 1 for the left across the depth of the cabinet. Dimensions of the product should be chosen so as to be equal with the depth of the cabinet.

BLANK PANELS

BLANK panels are cabinet accessories made of metal adaptable to all 19" cabinets functioning as closing unused U values – resulting from not installing a device or reserved – and stopping and/or directing hot/cold air flows. They also contribute to a proper appearance.

XX= Color Code, 02 means Light Grey RAL 7035 and 01 means Black RAL 9005, the code is added by the customer at the order.

SCREW TYPE BLANK PANELS

Product Code	Product Description	Product Dimensions WxDxH (mm)	Package Dimensions WxDxH (mm)	Product Net Weight (kg)	Product Gross Weight (kg)	Number in the Package (pcs)	Box Dimensions WxDxH (mm)	Box Gross Weight (kg)
MR.PKV1UXX	1U 19" screw type blank panel	482x15x44	500x22x55	0,25	0,29	40	560x425x122	13,5
MR.PKV2UXX	2U 19" screw type blank panel	482x15x88	500x22x147	0,41	0,5	36	560x428x122	19
MR.PKV3UXX	3U 19" screw type blank panel	482x15x132	500x22x147	0,57	0,66	40	545x425x400	28,7
MR.PKV4UXX	4U 19" screw type blank panel	482x15x176	490x22x182	0,78	0,9	40	545x425x400	39,2
MR.PKV5UXX	5U 19" screw type blank panel	482x15x220	490x22x225	0,95	1,06	40	550x430x480	44,1
MR.PKV6UXX	6U 19" screw type blank panel	482x15x264	490x22x270	1,13	1,27	42	550x450x630	55,7

They are blank panels with a closed surface and installed with screws

COLOR OPTIONS

RAL 7035 LIGHT GREY RAL 9005 BLACK

SCREW TYPE, VENTED BLANK PANELS

Product Code	Product Description	Product Dimensions WxDxH (mm)	Package Dimensions WxDxH (mm)	Product Net Weight (kg)	Product Gross Weight (kg)	Number in the Package (pcs)	Box Dimensions WxDxH (mm)	Box Gross Weight (kg)
MR.PSV1UXX	1U 19" screw type, vented blank panel	482x15x44	500x22x55	0,22	0,26	40	560x425x122	12,3
MR.PSV2UXX	2U 19" screw type, vented blank panel	482x15x88	500x22x147	0,38	0,47	36	560x428x122	18
MR.PSV3UXX	3U 19" screw type, vented blank panel	482x15x132	500x22x147	0,54	0,63	40	545x425x400	27,5
MR.PSV4UXX	4U 19" screw type, vented blank panel	482x15x176	490x22x182	0,75	0,87	40	545x425x400	38
MR.PSV5UXX	5U 19" screw type, vented blank panel	482x15x220	490x22x225	0,92	1,03	40	550x430x480	43
MR.PSV6UXX	6U 19" screw type, vented blank panel	482x15x264	490x22x270	1,1	1,24	42	550x450x630	54,5

They are blank panels with a closed surface and installed with screws

COLOR OPTIONS

RAL 7035 LIGHT GREY RAL 9005 BLACK

TOOLLESS MOUNTING BLANK PANELS

Product Code	Product Description	Product Dimensions WxDxH (mm)	Package Dimensions WxDxH (mm)	Product Net Weight (kg)	Product Gross Weight (kg)	Number in the Package (pcs)	Box Dimensions WxDxH (mm)	Box Gross Weight (kg)
MR.PKT1UXX	1U 19" toolless mounting, blank panel	482x15x44	500x22x55	0,25	0,29	40	560x425x122	13,5
MR.PKT2UXX	2U 19" toolless mounting, blank panel	482x15x88	500x22x147	0,41	0,5	36	560x428x122	19
MR.PKT3UXX	3U 19" toolless mounting, blank panel	482x15x132	500x22x147	0,57	0,66	40	545x425x400	28,7
MR.PKT4UXX	4U 19" toolless mounting, blank panel	482x15x176	490x22x182	0,78	0,9	40	545x425x400	39,2
MR.PKT5UXX	5U 19" toolless mounting, blank panel	482x15x220	490x22x225	0,95	1,06	40	550x430x480	44,1
MR.PKT6UXX	6U 19" toolless mounting, blank panel	482x15x264	490x22x270	1,13	1,27	42	550x450x630	55,7

They are shielded panels which are mounted with manually screwed clips, without use of a tool.

COLOR OPTIONS

RAL 7035 LIGHT GREY RAL 9005 BLACK

TOOLLESS MOUNTING, VENTED BLANK PANELS

Product Code	Product Description	Product Dimensions WxDxH (mm)	Package Dimensions WxDxH (mm)	Product Net Weight (kg)	Product Gross Weight (kg)	Number in the Package (pcs)	Box Dimensions WxDxH (mm)	Box Gross Weight (kg)
MR.PST1UXX	1U 19" toolless mounting, vented blank panel	482x15x44	500x22x55	0,22	0,26	40	560x425x122	12,3
MR.PST2UXX	2U 19" toolless mounting, vented blank panel	482x15x88	500x22x147	0,38	0,47	36	560x428x122	18
MR.PST3UXX	3U 19" toolless mounting, vented blank panel	482x15x132	500x22x147	0,54	0,63	40	545x425x400	27,5
MR.PST4UXX	4U 19" toolless mounting, vented blank panel	482x15x176	490x22x182	0,75	0,87	40	545x425x400	38
MR.PST5UXX	5U 19" toolless mounting, vented blank panel	482x15x220	490x22x225	0,92	1,03	40	550x430x480	43
MR.PST6UXX	6U 19" toolless mounting, vented blank panel	482x15x264	490x22x270	1,1	1,24	42	550x450x630	54,5

They are shielded slot panels which are mounted with manually screwed clips, without use of a tool.

COLOR OPTIONS

RAL 7035 LIGHT GREY RAL 9005 BLACK

SNAP LOCKING BLANK PANELS

Product Code	Product Description	Product Dimensions WxDxH (mm)	Package Dimensions WxDxH (mm)	Product Net Weight (kg)	Product Gross Weight (kg)	Number in the Package (pcs)	Box Dimensions WxDxH (mm)	Box Gross Weight (kg)
MR.PKS1UXX	1U 19" snap locking blank panel	482x15x44	500x22x55	0,25	0,29	40	560x425x122	13,5
MR.PKS2UXX	2U 19" snap locking blank panel	482x15x88	500x22x147	0,41	0,5	36	560x428x122	19
MR.PKS3UXX	3U 19" snap locking blank panel	482x15x132	500x22x147	0,57	0,66	40	545x425x400	28,7
MR.PKS4UXX	4U 19" snap locking blank panel	482x15x176	490x22x182	0,78	0,9	40	545x425x400	39,2
MR.PKS5UXX	5U 19" snap locking blank panel	482x15x220	490x22x225	0,95	1,06	40	550x430x480	44,1
MR.PKS6UXX	6U 19" snap locking blank panel	482x15x264	490x22x270	1,13	1,27	42	550x450x630	55,7

These blank panels are mounted by the snap locks found on the right and the left, without use of a tool.

COLOR OPTIONS

RAL 7035 LIGHT GREY RAL 9005 BLACK

SNAP LOCKING VENTED BLANK PANELS

Product Code	Product Description	Product Dimensions WxDxH (mm)	Package Dimensions WxDxH (mm)	Product Net Weight (kg)	Product Gross Weight (kg)	Number in the Package (pcs)	Box Dimensions WxDxH (mm)	Box Gross Weight (kg)
MR.PSS1UXX	1U 19" snap locking, vented blank panel	482x15x44	500x22x55	0,25	0,29	40	560x425x122	13,5
MR.PSS2UXX	2U 19" snap locking, vented blank panel	482x15x88	500x22x147	0,41	0,5	36	560x428x122	19
MR.PSS3UXX	3U 19" snap locking, vented blank panel	482x15x132	500x22x147	0,57	0,66	40	545x425x400	28,7
MR.PSS4UXX	4U 19" snap locking, vented blank panel	482x15x176	490x22x182	0,78	0,9	40	545x425x400	39,2
MR.PSS5UXX	5U 19" snap locking, vented blank panel	482x15x220	490x22x225	0,95	1,06	40	550x430x480	44,1
MR.PSS6UXX	6U 19" snap locking, vented blank panel	482x15x264	490x22x270	1,13	1,27	42	550x450x630	55,7

These blank panels are mounted by the flap locks found on the right and the left, without use of a tool.

COLOR OPTIONS

RAL 7035 LIGHT GREY RAL 9005 BLACK

EQUIPMENT MOUNTING RAILS

Product Code	Product Description	Product Dimensions WxDxH (mm)	Package Dimensions WxDxH (mm)	Product Net Weight (kg)	Product Gross Weight (kg)	Number in the Package (pcs)	Box Dimensions WxDxH (mm)	Box Gross Weight (kg)
MR.CMD07UZN	7U equipment mounting rail, 1set=2pcs (left/right)	50X30X406	55X35X430	0,8	0,9	1	55X35X430	0,9
MR.CMD09UZN	9U equipment mounting rail, 1set=2pcs (left/right)	50X30X495	55X35X520	1	1,1	1	55X35X520	1,1
MR.CMD12UZN	12U equipment mounting rail 1set=2pcs (left/right)	50X30X628	55X35X650	1,3	1,4	1	55X35X650	1,4
MR.CMD16UZN	16U equipment mounting rail 1set=2pcs (left/right)	50X30X806	55X35X830	1,6	1,7	1	55X35X830	1,7
MR.CMD20UZN	20U equipment mounting rail 1set=2pcs (left/right)	50X30X984	55X35X1010	2	2,1	1	55X35X1010	2,1
MR.CMD22UZN	22U equipment mounting rail 1set=2pcs (left/right)	50X30X1060	55X35X1080	2,1	2,2	1	55X35X1080	2,2
MR.CMD26UZN	26U equipment mounting rail 1set=2pcs (left/right)	50X30X1235	55X35X1260	2,5	2,6	1	55X35X1260	2,6
MR.CMD32UZN	32U equipment mounting rail 1set=2pcs (left/right)	50X30X1500	55X35X1520	3	3,1	1	55X35X1520	3,1
MR.CMD36UZN	36U equipment mounting rail 1set=2pcs (left/right)	50X30X1675	55X35X1700	3,3	3,4	1	55X35X1700	3,4
MR.CMD40UZN	40U equipment mounting rail 1set=2pcs (left/right)	50X30X1850	55X35X1870	3,7	3,8	1	55X35X1870	3,8
MR.CMD42UZN	42U equipment mounting rail 1set=2pcs (left/right)	50X30X1935	55X35X1960	3,8	3,9	1	55X35X1960	3,9
MR.CMD46UZN	46U equipment mounting rail 1set=2pcs (left/right)	50X30X2110	55X35X2130	4,2	4,3	1	55X35X2130	4,3

Equipment mounting rails are accessories for connecting devices into the cabinets, adaptable to all Wall Type and Free Standing type MirsanRack cabinets which are made of 1.5 mm metal and having high resistance and carrying capacity thanks to the twisted structure. They are delivered as 1 set: 2 pieces.

DRAWER MODULES (LOCKABLE)

Product Code	Product Description	Product Dimensions WxDxH (mm)	Package Dimensions WxDxH (mm)	Product Net Weight (kg)	Product Gross Weight (kg)	Number in the Package (pcs)	Box Dimensions WxDxH (mm)	Box Gross Weight (kg)
MR.CEK1UXX	1U 19" keyboard and general use, lockable drawer module	482x400x45	510x420x60	3,6	4	6	545x425x400	26
MR.CEK2UXX	2U 19" keyboard and general use, lockable drawer module	482x400x90	510x420x110	5,5	6	4	545x425x400	26
MR.CEK3UXX	3U 19" keyboard and general use, lockable drawer module	482x400x135	510x420x155	7,1	7,7	3	550x430x480	25
MR.CEK6UXX	6U 19" keyboard and general use, lockable drawer module	482x400x270	510x420x290	11	11,5	1	545x425x400	13

Rack modules are general purpose housings, lockable and adaptable to all 19" cabinets. They can be easily installed to any depth by means of adjustable depth side brackets found in the front and in the back. With its specially designed side panels of extruded aluminum it presents a robust and high resistance structure.

COLOR OPTIONS

RAL 7035 LIGHT GREY RAL 9005 BLACK

XX= Color Code, 02 means Light Grey RAL 7035 and 01 means Black RAL 9005, the code is added by the customer at the order.

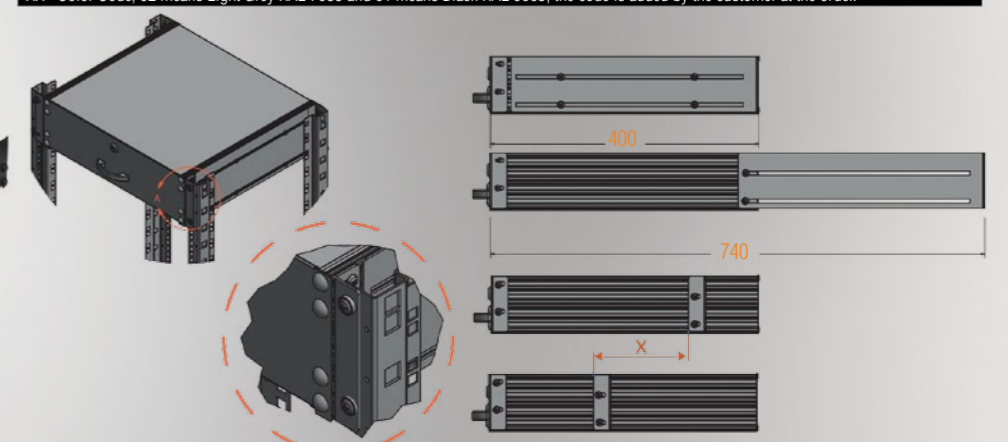

BAYING KIT

Product Code	Product Description	Product Dimensions WxDxH (mm)	Package Dimensions WxDxH (mm)	Product Net Weight (kg)	Product Gross Weight (kg)	Number in the Package (pcs)	Box Dimensions WxDxH (mm)	Box Gross Weight (kg)
MR.BKKXX	Cabinet baying kit, 1set= 4pcs.	100x50x30	270x165x50	0,45	0,5	96	550X430X400	49

They are metal accessories used for connecting GT Series Cabinets side by side. Cabinet connection kit is installed to the cabinet by detaching the side doors. They are delivered as 1 set: 4 pieces.

COLOR OPTIONS

RAL 7035 LIGHT GREY RAL 9005 BLACK

XX= Color Code, 02 means Light Grey RAL 7035 and 01 means Black RAL 9005, the code is added by the customer at the order.

FIXING HARDWARE

Product Code	Product Description	Product Dimensions WxDxH (mm)	Package Dimensions WxDxH (mm)	Product Net Weight (kg)	Product Gross Weight (kg)	Number in the Package (pcs)	Box Dimensions WxDxH (mm)	Box Gross Weight (kg)
MR.KFS20	M6 cage nut set and mounting screws, 1set= 20pcs.	-	82x82x100	0,16	0,25	30	560x425x122	8,4
MR.KFS50	M6 cage nut set and mounting screws, 1set= 50pcs.	-	82x82x100	0,39	0,48	30	560x425x122	15,4

M6 steel cage nut set consists of cage nut, screw and rack type PVC washers. They are introduced as 20 piece or 50 piece packs.

COLOR OPTIONS

RAL 7035 LIGHT GREY RAL 9005 BLACK

CABLE ORGANIZER ACCESSORIES

19" HOOK ORGANIZER

Product Code	Product Description	Product Dimensions WxDxH (mm)	Package Dimensions WxDxH (mm)	Product Net Weight (kg)	Product Gross Weight (kg)	Number in the Package (pcs)	Box Dimensions WxDxH (mm)	Box Gross Weight (kg)
MR.OKP1U19.XX	1U 19" cable organizer panel with 5 hooks	482x72x44	490x80x50	0,32	0,35	32	545x425x400	12,8
MR.OKP2U 19.XX	2U 19" cable organizer panel with 5 hooks	482x72x88	490x85x95	0,65	0,72	16	545x425x400	13

They are cable organizers with 5 aluminum hooks and a metal installation base suitable for all 19" cabinets, which are used for organized and effective lodgment of cables.

They can be installed at two directions, horizontal or vertical, in (19")3 GT series cabinets.

COLOR OPTIONS
RAL 7035 LIGHT GREY RAL 9005 BLACK

XX= Color Code, 02 means Light Grey RAL 7035 and 01 means Black RAL 9005, the code is added by the customer at the order.

19" HOOK ORGANIZER WITH CABLE ENTRY HOLES

Product Code	Product Description	Product Dimensions WxDxH (mm)	Package Dimensions WxDxH (mm)	Product Net Weight (kg)	Product Gross Weight (kg)	Number in the Package (pcs)	Box Dimensions WxDxH (mm)	Box Gross Weight (kg)
MR.OKB1U19.XX	1U 19" Cable organizer panel with 5 hooks with cable entry holes	482x72x44	490x80x50	0,32	0,35	32	545x425x400	12,8
MR.OKB2U 19.XX	2U 19" cable organizer panel with 5 hooks with cable entry holes	482x72x88	490x85x95	0,65	0,72	16	545x425x400	13

They are cable organizers with 5 aluminum hooks and an installation base with cable entry holes suitable for all 19" cabinets, which are used for organized and effective lodgment of cables.

They can be installed at two directions, horizontal or vertical, in (19")3 GT series cabinets.

COLOR OPTIONS
RAL 7035 LIGHT GREY RAL 9005 BLACK

XX= Color Code, 02 means Light Grey RAL 7035 and 01 means Black RAL 9005, the code is added by the customer at the order.

SINGLE HOOK SETS

Product Code	Product Description	Product Dimensions WxDxH (mm)	Package Dimensions WxDxH (mm)	Product Net Weight (kg)	Product Gross Weight (kg)	Number in the Package (pcs)	Box Dimensions WxDxH (mm)	Box Gross Weight (kg)
MR.OKS05D30.01	Cable organizer hook set, metal 44x30mm, 1set=5pcs.	44x30	145x100x50	0,5	0,65	26	560x425x122	18
MR.OKS10D30.01	Cable organizer hook set, metal 44x30mm, 1set=10pcs.	44x30	145x100x50	1	1,15	26	560x425x122	31
MR.OKS05A60.01	Cable organizer hook set, aluminum 44x60mm, 1set=5pcs.	44x60	145x100x50	0,65	0,80	26	560x425x122	22
MR.OKS10A60.01	Cable organizer hook set, aluminum 44x60mm, 1set=10pcs.	44x60	145x100x50	1,3	1,45	26	560x425x122	39
MR.OKS05D100.01	Cable organizer hook set, metal 44x100mm, 1set=5pcs.	44x100	490x80x50	0,9	1,05	32	545x425x400	30
MR.OKS10D100.01	Cable organizer hook set, metal 44x100mm, 1set=10pcs.	44x100	490x80x50	1,8	2	20	545x425x400	38
MR.OKS05A88.01	Cable organizer hook set, aluminum 88x60mm, 1set=5pcs.	88x60	490x85x95	1	1,15	16	545x425x400	17,5
MR.OKS10A88.01	Cable organizer hook set, aluminum 88x60mm, 1set=10pcs.	88x60	490x85x95	2	2,15	16	545x425x400	33,5

They are simple organizer solutions as single hooks adaptable to all cabinets with 1U and 2U installation base.

They are introduced with 2 pack options as 5 pieces or 10 pieces in four sizes (44x30, 44x60, 44x100, 88x60).

COLOR OPTIONS
RAL 7035 LIGHT GREY RAL 9005 BLACK

XX= Color Code, 02 means Light Grey RAL 7035 and 01 means Black RAL 9005, the code is added by the customer at the order.

SIMPLE BRUSHED ORGANIZERS

Product Code	Product Description	Product Dimensions WxDxH (mm)	Package Dimensions WxDxH (mm)	Product Net Weight (kg)	Product Gross Weight (kg)	Number in the Package (pcs)	Box Dimensions WxDxH (mm)	Box Gross Weight (kg)
MR.OFB1U19.XX	1U 19" simple type, brushed cable organizer panel, patchcord entry hole	482x12x44	490x20x50	0,25	0,29	40	560x425x122	13,5
MR.OFBYU19.XX	1/2U 19" simple type, brushed cable organizer panel, patchcord entry hole	482x12x22	490x20x50	0,22	0,25	40	560x425x122	11

Brushed cable organizers are metal accessories, adaptable to all 19" cabinets and are used for preventing against dust and rendering an organized appearance as well by BLANK the cable harness by means of the brushes at the cable inlet holes.

They are introduced with 2 pack options as 5 pieces or 10 pieces in four sizes (44x30, 44x60, 44x100, 88x60).

COLOR OPTIONS
RAL 7035 LIGHT GREY RAL 9005 BLACK

XX= Color Code, 02 means Light Grey RAL 7035 and 01 means Black RAL 9005, the code is added by the customer at the order.

PATCHCORD CONVEYOR BRUSHED ORGANIZERS

Product Code	Product Description	Product Dimensions WxDxH (mm)	Package Dimensions WxDxH (mm)	Product Net Weight (kg)	Product Gross Weight (kg)	Number in the Package (pcs)	Box Dimensions WxDxH (mm)	Box Gross Weight (kg)
MR.OFL1U19.XX	1U 19" L bent, brushed cable organizer panel, patchcord cable entry hole	482x112x44	490x135x50	0,58	0,76	20	545x425x400	17
MR.OFLYU19.XX	1/2U 19" L bent, brushed cable organizer panel, patchcord cable entry hole	482x112x22	490x135x50	0,52	0,70	20	545x425x400	16

Brushed cable organizers with patchcord carriers prevent incoming dust with said brushes at the cable inlet holes as well as prevent cable sags by means of the L twists carrying the cables.

They are metal accessories suitable for all 19" cabinets.

COLOR OPTIONS
RAL 7035 LIGHT GREY RAL 9005 BLACK

XX= Color Code, 02 means Light Grey RAL 7035 and 01 means Black RAL 9005, the code is added by the customer at the order.



1U CABLE TIRE-UP PANELS

Product Code	Product Description	Product Dimensions WxDxH (mm)	Package Dimensions WxDxH (mm)	Product Net Weight (kg)	Product Gross Weight (kg)	Number in the Package (pcs)	Box Dimensions WxDxH (mm)	Box Gross Weight (kg)
MR.TUP60.XX	D=600 cable tire-up panel	282x10x44	290x20x50	0,25	0,33	1	290x20x50	0,33
MR.TUP80.XX	D=800 cable tire-up panel	482x10x44	490x20x50	0,33	0,43	1	490x20x50	0,43
MR.TUP100.XX	D=1000 cable tire-up panel	686x10x44	700x20x50	0,41	0,52	1	700x20x50	0,52

1U cable holding panels are metal accessories installed throughout the depth of the cabinets and enabling tiring-up and holding of cables by means of special pattern thereon.

They can be installed at two directions, horizontal or vertical, in (19")3 GT series cabinets.

COLOR OPTIONS
RAL 7035 LIGHT GREY RAL 9005 BLACK

XX= Color Code, 02 means Light Grey RAL 7035 and 01 means Black RAL 9005, the code is added by the customer at the order.

VERTICAL CABLE TRAYS

Product Code	Product Description	Product Dimensions WxDxH (mm)	Package Dimensions WxDxH (mm)	Product Net Weight (kg)	Product Gross Weight (kg)	Number in the Package (pcs)	Box Dimensions WxDxH (mm)	Box Gross Weight (kg)
MR.KNL12UZ	12U W=100mm cable tray	100x10x552	110x20x582	0,37	0,41	2	110x20x582	0,92
MR.KNL16UZ	16U W=100mm cable tray	100x10x730	110x20x752	0,42	0,48	2	110x20x752	0,97
MR.KNL20UZ	20U W=100mm cable tray	100x10x908	110x20x930	0,53	0,6	2	110x20x930	1,2
MR.KNL22UZ	22U W=100mm cable tray	100x10x996	110x20x1020	0,59	0,68	2	110x20x1020	1,36
MR.KNL26UZ	26U W=100mm cable tray	100x10x1175	110x20x1200	0,64	0,71	2	110x20x1200	1,43
MR.KNL32UZ	32U W=100mm cable tray	100x10x1440	110x20x1470	0,8	0,88	2	110x20x1470	1,77
MR.KNL36UZ	36U W=100mm cable tray	100x10x1620	110x20x1650	0,9	1,01	2	110x20x1650	2,02
MR.KNL40UZ	40U W=100mm cable tray	100x10x1752	110x20x1782	0,98	1,08	2	110x20x1782	2,16
MR.KNL42UZ	42U W=100mm cable tray	100x10x1885	110x20x1910	1,05	1,1	2	110x20x1910	2,2
MR.KNL46UZ	46U W=100mm cable tray	100x10x2020	110x20x2050	1,15	1,28	2	110x20x2050	2,56

Vertical cable trays are for free standing server cabinets, metal accessories with galvanized coating enabling tire-up of cables and distribution of them to the relevant equipment neatly by means of its dense slots thereon.

OMEGAS

Product Code	Product Description	Product Dimensions WxDxH (mm)	Package Dimensions WxDxH (mm)	Product Net Weight (kg)	Product Gross Weight (kg)	Number in the Package (pcs)	Box Dimensions WxDxH (mm)	Box Gross Weight (kg)
MR.OMG60.ZN	D=600 omega	95x410x20	110x430x40	0,37	0,5	60	550x430x400	31
MR.OMG80.ZN	D=800 omega	95x595x20	110x610x40	0,5	0,7	75	810x430x525	53,5
MR.OMG100.ZN	D=1000 omega	95x740x20	110x760x40	0,6	0,8	75	810x430x525	61

Omeegas are for tiring-up and carrying the cables connected across the depth of the cabinet between the installation rail and side bracket in W=800 cabinets.

Each omega may be connected to at least 1 side bracket. They may be used horizontally or vertically, in 2 positions. In horizontal utilizations, the length of the omega should be ordered so as to be equal to the depth value.

PATCH PANELS

CAT5 & CAT6 PATCH PANELS

Product Code	Product Description	Product Dimensions WxDxH (mm)	Package Dimensions WxDxH (mm)	Product Net Weight (kg)	Product Gross Weight (kg)	Number in the Package (pcs)	Box Dimensions WxDxH (mm)	Box Gross Weight (kg)
MR.PCP1U24.C5	1U 24 Port CAT5 Patch Panel	482x30x44	500x55x70	0,49	0,62	40	560x425x400	26
MR.PCP2U48.C5	2U 48 Port CAT5 Patch Panel	482x30x88	500x55x105	0,86	1	28	560x425x400	29
MR.PCP1U24.C6	1U 24 Port CAT6 Patch Panel	482x30x44	500x55x70	0,49	0,62	40	560x425x400	26
MR.PCP2U48.C6	2U 48 Port CAT6 Patch Panel	482x30x88	500x55x105	0,86	1	28	560x425x400	29

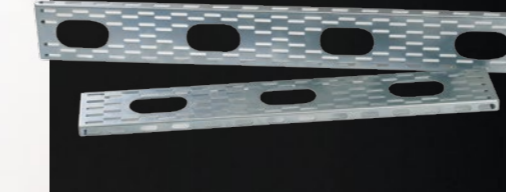
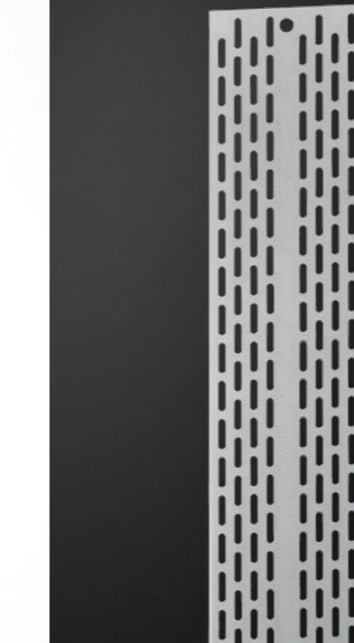

COVERED CABLE ORGANIZERS

VERTICAL CABLE MANAGEMENT ORGANIZERS

Product Code	Product Description	Product Dimensions WxDxH (mm)	Package Dimensions WxDxH (mm)	Product Net Weight (kg)	Product Gross Weight (kg)	Number in the Package (pcs)	Box Dimensions WxDxH (mm)	Box Gross Weight (kg)
MR.ODK22LXX	22U vertical cable organizer, 1set=2 pcs. (left/right)	92x92x1060	200x100x1080	6,2	6,7	1	200x100x1080	6,7
MR.ODK26LXX	26U vertical cable organizer, 1set=2 pcs. (left/right)	92x92x1240	200x100x1260	7,1	7,5	1	200x100x1260	7,5
MR.ODK32LXX	32U vertical cable organizer, 1set=2 pcs. (left/right)	92x92x1510	200x100x1530	8,4	9	1	200x100x1530	9
MR.ODK36LXX	36U vertical cable organizer, 1set=2 pcs. (left/right)	92x92x1685	200x100x1705	9,2	9,8	1	200x100x1705	9,8
MR.ODK40LXX	40U vertical cable organizer, 1set=2 pcs. (left/right)	92x92x1860	200x100x1880	10,1	10,6	1	200x100x1880	10,6
MR.ODK42LXX	42U vertical cable organizer, 1set=2 pcs. (left/right)	92x92x1955	200x100x1975	10,5	11	1	200x100x1975	11
MR.ODK46LXX	46U vertical cable organizer, 1set=2 pcs. (left/right)	92x92x2130	200x100x2150	11,4	12	1	200x100x2150	12

These cable organizers are for use inside the W=800 GT Series cabinets enabling organized and proper cabling inside the cabinet. They are installed in a vertical position and provided with a cover.

Thanks to the flap locked cover, it can be detached and re-installed within seconds. It renders a neat and a professional appearance to the cabinet by BLANK the cable harness when looked from the back or front. They are delivered as 1 set: 2 pieces (right/left).

COLOR OPTIONS
RAL 7035 LIGHT GREY RAL 9005 BLACK

XX= Color Code, 02 means Light Grey RAL 7035 and 01 means Black RAL 9005, the code is added by the customer at the order.

COVERED CABLE ORGANIZERS

19" covered cable organizers are accessories suitable for all 19" cabinets by housing the cable harness inside thereby BLANK them by means of its cover and rendering a neat appearance to the cabinet.

SLIDING COVER 19" ORGANIZERS

Product Code	Product Description	Product Dimensions WxDxH (mm)	Package Dimensions WxDxH (mm)	Product Net Weight (kg)	Product Gross Weight (kg)	Number in the Package (pcs)	Box Dimensions WxDxH (mm)	Box Gross Weight (kg)
MR.OKK1U19XX	1U 19" sliding cover cable management panel	482x72x44	490x80x50	0,68	0,72	32	545x425x400	24
MR.OKK2U19XX	2U 19" sliding cover cable management panel	482x72x88	490x85x95	1,35	1,47	16	545x425x400	25,5

Installation of the cover does not require screwing to be attached thanks to its design enabling affixation to the cabinet without use of a tool.

COLOR OPTIONS
RAL 7035 LIGHT GREY RAL 9005 BLACK

XX= Color Code, 02 means Light Grey RAL 7035 and 01 means Black RAL 9005, the code is added by the customer at the order.

S TYPE ORGANIZERS WITH COVER

Product Code	Product Description	Product Dimensions WxDxH (mm)	Package Dimensions WxDxH (mm)	Product Net Weight (kg)	Product Gross Weight (kg)	Number in the Package (pcs)	Box Dimensions WxDxH (mm)	Box Gross Weight (kg)
MR.OSK1U19XX	1U 19" S type cable management panel with cover	482x75x44	490x80x50	0,51	0,55	32	545x425x400	19,2
MR.OSK2U19XX	2U 19" S type cable management panel with cover	482x75x88	490x85x95	1,03	1,12	16	545x425x400	20

Thanks to the round plastic attachment pieces found at the corners of the cabinet, detachment and re-attachment of the cover does not require use of a tool.

COLOR OPTIONS
RAL 7035 LIGHT GREY RAL 9005 BLACK

XX= Color Code, 02 means Light Grey RAL 7035 and 01 means Black RAL 9005, the code is added by the customer at the order.

R TYPE ORGANIZERS WITH COVER

Product Code	Product Description	Product Dimensions WxDxH (mm)	Package Dimensions WxDxH (mm)	Product Net Weight (kg)	Product Gross Weight (kg)	Number in the Package (pcs)	Box Dimensions WxDxH (mm)	Box Gross Weight (kg)
MR.ORK1U19XX	1U 19" R type cable management panel with cover	482x75x44	490x80x50	0,51	0,55	32	545x425x400	19,2
MR.ORK2U19XX	2U 19" R type cable management panel with cover	482x75x88	490x85x95	1,03	1,12	16	545x425x400	20

Thanks to the plastic rectangular attachment pieces found at the corners of the cabinet, detachment and re-attachment of the cover does not require use of a tool.

COLOR OPTIONS
RAL 7035 LIGHT GREY RAL 9005 BLACK

XX= Color Code, 02 means Light Grey RAL 7035 and 01 means Black RAL 9005, the code is added by the customer at the order.

P TYPE ORGANIZERS WITH COVER

Product Code	Product Description	Product Dimensions WxDxH (mm)	Package Dimensions WxDxH (mm)	Product Net Weight (kg)	Product Gross Weight (kg)	Number in the Package (pcs)	Box Dimensions WxDxH (mm)	Box Gross Weight (kg)
MR.OPK2U19XX	2U 19" P type cable management panel with cover (finger type plastic organizer integrated)	482x165x88	500x180x95	1,6	1,8	8	545x425x400	16,5

Finger type plastic organizer allows opening of the cover towards up or down without use of a tool by means of bi-directional cover.

COLOR OPTIONS
RAL 7035 LIGHT GREY RAL 9005 BLACK

XX= Color Code, 02 means Light Grey RAL 7035 and 01 means Black RAL 9005, the code is added by the customer at the order.

GROUND GROUP

PINION FEET AND CASTER GROUPS

Product Code	Product Description	Product Dimensions WxDxH (mm)	Package Dimensions WxDxH (mm)	Product Net Weight (kg)	Product Gross Weight (kg)	Number in the Package (pcs)	Box Dimensions WxDxH (mm)	Box Gross Weight (kg)
MR.PNY25	PVC body, pinion feet, 1set=4pcs.	M10x55	80x82x100	0,2	0,3	30	560x425x122	10
MR.PNY80	Heavy duty type metal body pinion feet 1set=4pcs.	M10x90	80x82x100	0,25	0,35	30	560x425x122	11,5
MR.TKR525	Free standing type caster group, 4 point connection 1set=4pcs. (2 with brakes)	55x25	200x145x95	2	2,2	6	560x425x122	14,2
MR.TKR520	Wall type caster group, M10 pin 1set=4pcs. (2 with brakes)	M10	260x160x50	0,8	1	27	545x425x400	28

Pinion feet groups are of adjustable height and offers 2 options, one being made of PVC and the other of metal. They are delivered as 1 set: 4 pieces.

2 types of caster groups – Wall Type and Free Standing type (heavy duty) – are introduced as 360° movable across the y-axis, 2 with brakes and 2 without brakes, 4 pieces in total within 1 set.

BASES

Loading Capacity : 1000kg

Product Code	Product Description	Product Dimensions WxDxH (mm)	Package Dimensions WxDxH (mm)	Product Net Weight (kg)	Product Gross Weight (kg)	Number in the Package (pcs)	Box Dimensions WxDxH (mm)	Box Gross Weight (kg)
MR.BAZ66XX	W=600 D=600 H=100mm base module	570x570x100	600x600x130	7,9	9	1	600x600x130	9
MR.BAZ68XX	W=600 D=800 H=100mm base module	570x770x100	600x800x130	8,5	10	1	600x800x130	10
MR.BAZ61XX	W=600 D=1000 H=100mm base module	570x970x100	600x1000x130	9,1	10,4	1	600x1000x130	10,4
MR.BAZ86XX	W=800 D=600 H=100mm base module	770x570x100	800x600x130	8,5	10	1	800x600x130	10
MR.BAZ88XX	W=800 D=800 H=100mm base module	770x770x100	800x800x130	9,1	10,4	1	800x800x130	10,4
MR.BAZ81XX	W=800 D=1000 H=100mm base module	770x970x100	800x1000x130	9,7	11,4	1	800x1000x130	11,4

H=100mm bases are fully modular metal accessories of high strength designed for an extra space for housing the cables below the cabinet and also for rising the cabinet from the ground.

Front and side surfaces are closed and they bear a brushed cable entry hole at their back for cable inlets and outlets.

COLOR OPTIONS
RAL 7035 LIGHT GREY RAL 9005 BLACK

XX= Color Code, 02 means Light Grey RAL 7035 and 01 means Black RAL 9005, the code is added by the customer at the order.

GROUND CONNECTION KIT

Product Code	Product Description	Product Dimensions WxDxH (mm)	Package Dimensions WxDxH (mm)	Product Net Weight (kg)	Product Gross Weight (kg)	Number in the Package (pcs)	Box Dimensions WxDxH (mm)	Box Gross Weight (kg)
MR.BKZXX	Ground connection kit, 1set=4pcs.	90x90x45	270x165x50	1	1,2	4	545x425x122	5,5

It is a fully modular metal, high strength accessory allowing the connection of the cabinets to the ground for the purpose of securing against turnovers and shakings.

COLOR OPTIONS
RAL 7035 LIGHT GREY RAL 9005 BLACK

XX= Color Code, 02 means Light Grey RAL 7035 and 01 means Black RAL 9005, the code is added by the customer at the order.



EXTERIOR SHELVES

Loading Capacity : 30kg

Product Code	Product Description	Product Dimensions WxDxH (mm)	Package Dimensions WxDxH (mm)	Product Net Weight (kg)	Product Gross Weight (kg)	Number in the Package (pcs)	Box Dimensions WxDxH (mm)	Box Gross Weight (kg)
MR.DSR60.XX	D=600 exterior shelf	570x410x70	600x430x90	2,7	3	7	800x430x510	22,5
MR.DSR80.XX	D=800 exterior shelf	770x410x70	800x430x90	3,5	3,8	5	800x430x510	20,5

XX= Color Code, 02 means Light Grey RAL 7035 and 01 means Black RAL 9005, the code is added by the customer at the order.

COLOR OPTIONS
 RAL 7035 LIGHT GREY RAL 9005 BLACK

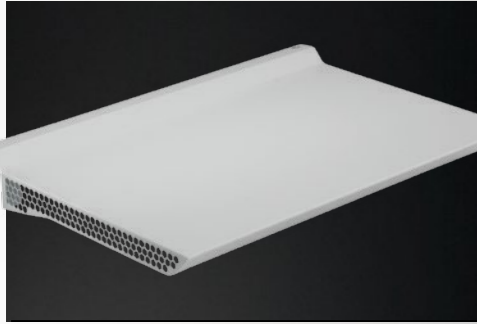

They are attached to the sides and back of GT Series 16U Versatile cabinets, turning the top surface of the cabinet into a desk.



FIELD OF USE

Factories, Offices, Storerooms. Available for use as open system PC Case.

EASY TO INSTALL

As all of the rack modules are modular, they can easily be installed and demounted when desired.

Width of the racks, introduced at 2 different widths, should be equal to the width (attachment at the back) or depth (attachment at the side) of your cabinet.

LIGHTING MODULES & 1U LUG

Product Code	Product Description	Product Dimensions WxDxH (mm)	Package Dimensions WxDxH (mm)	Product Net Weight (kg)	Product Gross Weight (kg)	Number in the Package (pcs)	Box Dimensions WxDxH (mm)	Box Gross Weight (kg)
MR.AYQ.XX	1U 19" led lighting module with automatic movement sensor	482x35x44	500x150x55	0,48	0,65	32	545x425x400	22
MR.AYM.XX	1U 19" led lighting module, manual on/off switch	482x35x44	500x150x55	0,54	0,7	32	545x425x400	23,5
MR.AYK.XX	1U 90° rotating lug module (for lighting)	44x30x25	60x40x35	0,15	0,2	16	270x165x50	3,8

Lightening modules are of extruded aluminum of 19" width, 1U height equipped with LED lightening.

Automatic lightening module has an internal automatic motion sensor integrated to aluminum frame panel.

Manual lightening module is turned on and off via on/off switch on the aluminum frame panel.

Flap module of 1U height allows turning the automatic manual lightening modules 90° by attaching thereto.

COLOR OPTIONS
 RAL 7035 LIGHT GREY RAL 9005 BLACK

XX= Color Code, 02 means Light Grey RAL 7035 and 01 means Black RAL 9005, the code is added by the customer at the order.

3U 19" ELECTRICAL DISTRIBUTION MODULES

Product Code	Product Description	Product Dimensions WxDxH (mm)	Package Dimensions WxDxH (mm)	Product Net Weight (kg)	Product Gross Weight (kg)	Number in the Package (pcs)	Box Dimensions WxDxH (mm)	Box Gross Weight (kg)
MR.EDM3U19A.XX	3U 19" electrical distribution module, with busbar	482x123x133	500x150x155	2,6	2,9	4	545x425x400	13,6
MR.EDM3U19B.XX	3U 19" electrical distribution module, 2 pcs. without busbar	482x123x133	500x150x155	2,8	3,1	4	545x425x400	14,4
MR.EDM3U19C.XX	3U 19" electrical distribution module, 4 pcs. without busbar	482x123x133	500x150x155	3	3,3	4	545x425x400	15,2

Electrical distribution modules are metal accessories, suitable for all 19" cabinets, designed for electrical distribution inside the cabinet. Three types of electrical distribution modules – without grounding busbar, with 2 busbars, 4 busbars- are delivered with integrated DIN ray and breakable plastic BLANK piece.

They have a 380mm entry opening and are suitable for all circuit breaker and power plug module within this width.

COLOR OPTIONS
 RAL 7035 LIGHT GREY RAL 9005 BLACK

XX= Color Code, 02 means Light Grey RAL 7035 and 01 means Black RAL 9005, the code is added by the customer at the order.

3U 19" TELEPHONE DISTRIBUTION MODULES

Product Code	Product Description	Product Dimensions WxDxH (mm)	Package Dimensions WxDxH (mm)	Product Net Weight (kg)	Product Gross Weight (kg)	Number in the Package (pcs)	Box Dimensions WxDxH (mm)	Box Gross Weight (kg)
MR.TDM3U19.XX	3U 19" telephone distribution module	482x123x133	500x150x155	2,4	2,7	4	545x425x400	12,8

Telephone distribution modules are metal accessories, suitable for all 19" cabinets, designed for telephone distribution inside the cabinet.

They are made of stainless material and delivered with reglet roofs.

It has 150 double distribution capacity.

COLOR OPTIONS
 RAL 7035 LIGHT GREY RAL 9005 BLACK

XX= Color Code, 02 means Light Grey RAL 7035 and 01 means Black RAL 9005, the code is added by the customer at the order.

EARTHING SETS

6 EARTHING POINT

Product Code	Product Description	Product Dimensions WxDxH (mm)	Package Dimensions WxDxH (mm)	Product Net Weight (kg)	Product Gross Weight (kg)	Number in the Package (pcs)	Box Dimensions WxDxH (mm)	Box Gross Weight (kg)
MR.TPS01	1U 19" 1 busbar earthing set with metal mounting base	260x55x50	260x55x50	0,2	0,3	32	550x430x400	11

It is a grounding set for cabinets bearing 6 grounding points thereon with a 220mm length copper busbar and 4 yellow-green grounding wires of 400mm length and 4mm diameter.

10 EARTHING POINT

Product Code	Product Description	Product Dimensions WxDxH (mm)	Package Dimensions WxDxH (mm)	Product Net Weight (kg)	Product Gross Weight (kg)	Number in the Package (pcs)	Box Dimensions WxDxH (mm)	Box Gross Weight (kg)
MR.TPS02.XX	1U 19" 1 busbar earthing set with metal mounting base	482x35x44	500x545x50	0,4	0,5	1	500x45x50	0,5

It is a grounding set suitable for all 19" cabinets bearing 10 grounding points thereon with a 400mm length copper busbar and 4 yellow-green grounding wires of 400mm length and 4mm diameter, introduced with a 1U metal installation base and attached to the panel.

COLOR OPTIONS
 RAL 7035 LIGHT GREY RAL 9005 BLACK

XX= Color Code, 02 means Light Grey RAL 7035 and 01 means Black RAL 9005, the code is added by the customer at the order.

44 EARTHING POINT

Product Code	Product Description	Product Dimensions WxDxH (mm)	Package Dimensions WxDxH (mm)	Product Net Weight (kg)	Product Gross Weight (kg)	Number in the Package (pcs)	Box Dimensions WxDxH (mm)	Box Gross Weight (kg)
MR.TPS42	Vertical use earthing set with 2 earthing busbar	25x25x780	35x35x800	1,5	1,7	1	35x35x800	1,7

It is a grounding set installed vertically on the cabinet bearing 22 grounding points thereon with a 780 mm length copper busbar (22x2-44 connection points), 4 yellow-green grounding wires of 400mm length and 4mm diameter and a jumper cable of 100 mm length and 16 mm diameter.

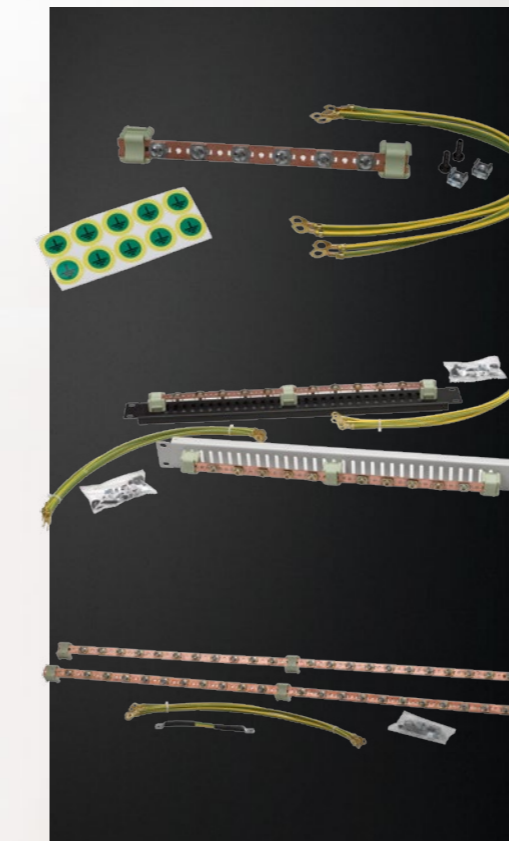

10" ACCESSORIES

8 PORT PATCH PANEL

Product Code	Product Description	Product Dimensions WxDxH (mm)	Package Dimensions WxDxH (mm)	Product Net Weight (kg)	Product Gross Weight (kg)	Number in the Package (pcs)	Box Dimensions WxDxH (mm)	Box Gross Weight (kg)
MR.10P8P1U.01	1U 10" patch panel, empty RJ45 compatible	254x12x44	265x20x50	0,27	0,31	66	560x425x122	21,5

It is an empty patch panel of 1U height, 10" width, suitable for eight RJ45.

COLOR OPTIONS
 RAL 7035 LIGHT GREY RAL 9005 BLACK

XX= Color Code, 02 means Light Grey RAL 7035 and 01 means Black RAL 9005, the code is added by the customer at the order.

1U D=150 SHELF

Loading Capacity : 5kg

Product Code	Product Description	Product Dimensions WxDxH (mm)	Package Dimensions WxDxH (mm)	Product Net Weight (kg)	Product Gross Weight (kg)	Number in the Package (pcs)	Box Dimensions WxDxH (mm)	Box Gross Weight (kg)
MR.RAK1U15.XX	1U 10" D=150mm shelf module	254x150x44	270x165x50	0,37	0,45	32	545x425x400	15,5

It is a cabinet rack made of metal, used for carrying small network equipments of 1U height, 10" width, D=150mm, bearing ventilation slots thereon.

COLOR OPTIONS
 RAL 7035 LIGHT GREY RAL 9005 BLACK

XX= Color Code, 02 means Light Grey RAL 7035 and 01 means Black RAL 9005, the code is added by the customer at the order.

1U BLANK PANEL

Product Code	Product Description	Product Dimensions WxDxH (mm)	Package Dimensions WxDxH (mm)	Product Net Weight (kg)	Product Gross Weight (kg)	Number in the Package (pcs)	Box Dimensions WxDxH (mm)	Box Gross Weight (kg)
MR.10PK1U1X.XX	1U 10" screw type blank panel	254x12x44	265x20x50	0,31	0,35	66	560x425x122	24

It is a BLANK panel with closed surfaces of 1U height, 10" width and used for BLANK idle and reserved U values in order to render an ordered appearance.

COLOR OPTIONS
 RAL 7035 LIGHT GREY RAL 9005 BLACK

XX= Color Code, 02 means Light Grey RAL 7035 and 01 means Black RAL 9005, the code is added by the customer at the order.

ORGANIZER WITH 3 HOOKS

Product Code	Product Description	Product Dimensions WxDxH (mm)	Package Dimensions WxDxH (mm)	Product Net Weight (kg)	Product Gross Weight (kg)	Number in the Package (pcs)	Box Dimensions WxDxH (mm)	Box Gross Weight (kg)
MR.OKP1U10.XX	1U 10" cable management panel, 3 pcs. Hook	254x42x44	260x50x50	0,21	0,25	64	545x425x400	17,5

It is a horizontal cable organizer made of metal of 1U height, 10" width and attached on the panel with 3, 44x30 hooks.

COLOR OPTIONS
 RAL 7035 LIGHT GREY RAL 9005 BLACK

XX= Color Code, 02 means Light Grey RAL 7035 and 01 means Black RAL 9005, the code is added by the customer at the order.

1/2U BRUSHED ORGANIZER

Product Code	Product Description	Product Dimensions WxDxH (mm)	Package Dimensions WxDxH (mm)	Product Net Weight (kg)	Product Gross Weight (kg)	Number in the Package (pcs)	Box Dimensions WxDxH (mm)	Box Gross Weight (kg)
MR.OFBYU10.XX	1/2U 10" simple type, brushed cable organizer panel, patchcord entry hole	254x12x22	265x20x50	0,07	0,11	66	560x425x122	8,5

It is a cable organizer made of metal material of (1/2)U height, 10" width with a brushed cable inlet module.

COLOR OPTIONS
 RAL 7035 LIGHT GREY RAL 9005 BLACK

XX= Color Code, 02 means Light Grey RAL 7035 and 01 means Black RAL 9005, the code is added by the customer at the order.

GROUP PLUG MODULE WITH 3 PLUGS

Product Code	Product Description	Product Dimensions WxDxH (mm)	Package Dimensions WxDxH (mm)	Product Net Weight (kg)	Product Gross Weight (kg)	Number in the Package (pcs)	Box Dimensions WxDxH (mm)	Box Gross Weight (kg)
MR.10PRZ1U30.SC.XX	1U 10" mounting base, 3 plugs PVC group socket module, on/off switch	254x100x44	270x165x50	0,6	0,7	14	560x425x122	11

It is a 3 pin PVC power plug module made of metal material of 1U height, 10" width with an installation base.

COLOR OPTIONS
 RAL 7035 LIGHT GREY RAL 9005 BLACK

XX= Color Code, 02 means Light Grey RAL 7035 and 01 means Black RAL 9005, the code is added by the customer at the order.

PLUGS

19" PLUG MODULES

Product Code	Product Description	Product Dimensions WxDxH (mm)	Package Dimensions WxDxH (mm)	Product Net Weight (kg)	Product Gross Weight (kg)	Number in the Package (pcs)	Box Dimensions WxDxH (mm)	Box Gross Weight (kg)
MR.PRZ1U60.SC	6xDIN49440 Socket Schuko Group Plug 1U casing, on/off switch, DIN 49441 plug	482x44x44	500x50x120	1	1,1	27	545x425x400	31
MR.PRZ1U60.SC.UK	6xDIN49440 Socket Schuko Group Plug 1U casing, on/off switch, 13A BS1363 plug	482x44x62	500x100x120	1,2	1,4	24	545x425x400	34
MR.PRZ1U80.SC	8xDIN49440 Socket Schuko Group Plug 1U casing, on/off switch, DIN 49441 plug	482x44x44	500x50x120	1,1	1,2	27	545x425x400	34
MR.PRZ1U6S.SC	6xDIN49440 Socket Schuko Group Plug 1U casing, 1x16A fuse protected, DIN 49441 plug	482x44x44	500x50x120	1	1,1	27	545x425x400	31
MR.PRZ1U6S.IE	6xIEC 320 C13 Socket Group Plug, 1U casing, 1x16A fuse protected, DIN 49441 plug	482x44x44	500x50x120	1	1,1	27	545x425x400	31
MR.PRZ2U6D.SC	6xDIN49440 Socket Schuko Group Plug 2U casing, 2pcs. 1x16A fuse protected, double circuit (3-3), DIN 49441 plug	482x44x88	500x100x120	1,2	1,4	12	545x425x400	18,5
MR.PRZ2U6D.IE	6xIEC 320 C13 Socket Group Plug 2U casing, 2pcs. 1x16A fuse protected, double circuit (3-3), DIN 49441 plug	482x44x88	500x100x120	1,2	1,4	12	545x425x400	18,5
MR.PRZ2U9S.SC	9xDIN49440 Socket Schuko Group Plug 2U casing, 1x16A fuse protected, DIN 49441 plug	482x44x88	500x100x120	1,5	1,7	12	545x425x400	22
MR.PRZ2U9S.IE	9xIEC 320 C13 Socket Group Plug 2U casing, 1x16A fuse protected, DIN 49441 plug	482x44x88	500x100x120	1,5	1,7	12	545x425x400	22
MR.PRZ2U9D.SC	9xDIN49440 Socket Schuko Group Plug 2U casing, 2pcs. 1x16A fuse protected, double circuit (4-5), DIN 49441 plug	482x44x88	500x100x120	1,6	1,8	12	545x425x400	23
MR.PRZ2U9D.IE	9xIEC 320 C13 Socket Group Plug 2U casing, 2pcs. 1x16A fuse protected, double circuit (4-5), DIN 49441 plug	482x44x88	500x100x120	1,6	1,8	12	545x425x400	23

They are group power plug modules of 19" width, aluminum profile carcass, Schuko type, with 2.5m electrical cable, plug and inner cabling, introduced as readily functioning with CE approval.



VERTICAL USE PLUG MODULES

Product Code	Product Description	Product Dimensions WxDxH (mm)	Package Dimensions WxDxH (mm)	Product Net Weight (kg)	Product Gross Weight (kg)	Number in the Package (pcs)	Box Dimensions WxDxH (mm)	Box Gross Weight (kg)
MR.PRZ26U12D.SC	12xDIN49440 Socket Schuko Group Plug 26U cabinet height, 2pcs. 1x16A fuse protected, double circuit (6-6), cordless, connector on the entrance	60x420x1180	1250x95x85	1,7	2,1	1	1250x95x85	2,1
MR.PRZ36U18D.SC	18xDIN49440 Socket Schuko Group Plug 36U cabinet height, 2pcs. 1x16A fuse protected, double circuit (9-9), cordless, connector on the entrance	60x420x1620	1710x95x85	2,4	2,9	1	1710x95x85	2,9
MR.PRZ42U18D.SC	18xDIN49440 Socket Schuko Group Plug 42U cabinet height, 2pcs. 1x16A fuse protected, double circuit (9-9), cordless, connector on the entrance	60x42x1890	2035x95x85	2,7	3,1	1	2035x95x85	3,1
MR.PRZ26U12D.IE	12xIEC 320 C13 Socket Group Plug 26U cabinet height, 2pcs. 1x16A fuse protected, double circuit (6-6), cordless, connector on the entrance	60x420x1180	1250x95x85	1,7	2,1	1	1250x95x85	2,1
MR.PRZ36U18D.IE	18xIEC 320 C13 Socket Group Plug 36U cabinet height, 2pcs. 1x16A fuse protected, double circuit (9-9), cordless, connector on the entrance	60x420x1620	1710x95x85	2,4	2,9	1	1710x95x85	2,9
MR.PRZ42U18D.IE	18xIEC 320 C13 Socket Group Plug 42U cabinet height, 2pcs. 1x16A fuse protected, double circuit (9-9), cordless, connector on the entrance	60x42x1890	2035x95x85	2,7	3,1	1	2035x95x85	3,1

They are power plug modules with CE approval, suitable for vertically mounting throughout the cabinet, made of aluminum profile carcass, introduced with a circuit breaker, dual circuit, 250V AC, and with a terminal at the one side.

FAN MODULES

CE APPROVAL

All 19" fan modules are with CE certificate approval suitable for 19" cabinet installation.

FUNCTIONALITY

They provide unique functionality and ventilation ability to all of 19" GT Series cabinets by being able to attach them from the front, sides, top and bottom.

VENTILATION CAPACITY

Each of the fan motor used in the fan modules have a 2.22m³/min to 2.7m³/min suction and discharge capacity and 43db to 47bn noise level.

19" STRUCTURE

Owing to their special 19" design, they are able to attach to 19" device installation rails of all trademarks and models.

U HEIGHTS

Fan plates;
H=3U, for fan plates of 2,
H=6U, for fan plates of 4,
H=9U, for fan plates of 6,
H=12U, for fan plates of 8,
H=15U, for fan plates of 10,
H=18U, for fan plates of 12,

19" FAN MODULES

Product Code	Product Description	Product Dimensions WxDxH (mm)	Package Dimensions WxDxH (mm)	Product Net Weight (kg)	Product Gross Weight (kg)	Number in the Package (pcs)	Box Dimensions WxDxH (mm)	Box Gross Weight (kg)
MR.FAN10NXX	1fan, on/off controlled fan module	490x135x45	510x170x85	1,1	1,3	10	550x430x440	14
MR.FAN1ATXX	1fan, analog thermostat controlled fan module	490x135x45	510x170x85	1,3	1,5	10	550x430x440	16
MR.FAN1WDTXX	1fan, built-in analog thermostat controlled fan module	490x135x45	510x170x85	1,2	1,4	10	550x430x440	15
MR.FAN1DTXX	1fan, digital thermostat controlled fan module	490x135x45	510x170x85	1,9	2,1	8	550x430x440	18
MR.FAN20NXX	2fans, on/off controlled fan module	490x135x45	510x170x85	1,8	2	10	550x430x440	21
MR.FAN2ATXX	2fans, analog thermostat controlled fan module	490x135x45	510x170x85	2	2,2	10	550x430x440	23
MR.FAN2WDTXX	2fans, built-in analog thermostat controlled fan module	490x135x45	510x170x85	1,9	2,1	10	550x430x440	22
MR.FAN2DTXX	2fans, digital thermostat controlled fan module	490x135x45	510x170x85	2,6	2,8	8	550x430x440	23,5
MR.FAN40NXX	4fans, on/off controlled fan module	490x270x45	510x320x65	3,3	3,6	8	550x430x440	30
MR.FAN4ATXX	4fans, analog thermostat controlled fan module	490x270x45	510x320x65	3,5	3,8	8	550x430x440	31,5
MR.FAN4DTXX	4fans, digital thermostat controlled fan module	490x270x45	510x320x65	4,1	4,4	6	550x430x440	27,5
MR.FAN60NXX	6fans, on/off controlled fan module	490x450x45	510x470x65	4,6	5	6	550x430x440	31
MR.FAN6ATXX	6fans, analog thermostat controlled fan module	490x450x45	510x470x65	4,8	5,2	6	550x430x440	32,5
MR.FAN6DTXX	6fans, digital thermostat controlled fan module	490x450x45	510x470x65	5,4	5,8	5	550x430x440	30
MR.FAN80NXX	8fans, on/off controlled fan module	490x600x45	510x620x65	6	6,5	6	550x430x572	40
MR.FAN8ATXX	8fans, analog thermostat controlled fan module	490x600x45	510x620x65	6,2	6,7	6	550x430x572	41
MR.FAN8DTXX	8fans, digital thermostat controlled fan module	490x600x45	510x620x65	6,8	7,3	5	550x430x572	37,5
MR.FAN100NXX	10fans, on/off controlled fan module	490x720x45	510x740x65	7,3	7,9	6	810x430x525	48,5
MR.FAN10ATXX	10fans, analog thermostat controlled fan module	490x720x45	510x740x65	7,5	8,1	6	810x430x525	48,5
MR.FAN10DTXX	10fans, digital thermostat controlled fan module	490x720x45	510x740x65	8,1	8,7	6	810x430x525	53
MR.FAN120NXX	12fans, on/off controlled fan module	490x850x45	510x870x65	8,6	9,3	1	510x870x65	9,3
MR.FAN12ATXX	12fans, analog thermostat controlled fan module	490x850x45	510x870x65	8,8	9,5	1	510x870x65	9,5
MR.FAN12DTXX	12fans, digital thermostat controlled fan module	490x850x45	510x870x65	9,4	10,1	1	510x870x65	10,1

XX= Color Code, 02 means Light Grey RAL 7035 and 01 means Black RAL 9005, the code is added by the customer at the order.

COLOR OPTIONS
RAL 7035 LIGHT GREY RAL 9005 BLACK

DIVERSE PRODUCT RANGE

They offer a wide range of product differing from plates with 1 fan to 12 fans, introduced without thermostat, with analogue thermostat and with digital thermostat.

GRADUAL VENTILATION

Rich variety of configurations may be possible in which fans with no thermostats, fans with analogue thermostat and fans with digital thermostat configurations are used together thanks to its side by side appendable feature.

2 POINT CONNECTED RACK MOUNT FAN MODULES

Product Code	Product Description	Product Dimensions WxDxH (mm)	Package Dimensions WxDxH (mm)	Product Net Weight (kg)	Product Gross Weight (kg)	Number in the Package (pcs)	Box Dimensions WxDxH (mm)	Box Gross Weight (kg)
MR.RFN20NXX	2fans, on/off controlled rack mount fan module	482x150x44	460x430x65	2,6	2,95	8	550x430x450	25
MR.RFN2ATXX	2fans, analog thermostat controlled rack mount fan module	482x150x44	460x430x65	2,8	3,15	9	550x430x450	29,3
MR.RFN2DTXX	2fans, digital thermostat controlled rack mount fan module	482x150x44	460x430x65	3	3,6	7	550x430x450	26,5
MR.RFN40NXX	4fans, on/off controlled rack mount fan module	482x300x44	460x430x65	4,95	5,3	8	550x430x450	44
MR.RFN4ATXX	4fans, analog thermostat controlled rack mount fan module	482x300x44	460x430x65	5,15	5,5	7	550x430x450	39,5
MR.RFN4DTXX	4fans, digital thermostat controlled rack mount fan module	482x300x44	460x430x65	5,3	5,6	6	550x430x450	35

All rackmount type fan modules are suitable for 19" cabinet installation.

Owing to their 19" design, they are able to attach to 19" device installation rails of all trademarks and models. They have 2 types of fan plates of 1U height with 2 fans and 4 fans.

They may be manufactured as 3 types of control units with the models being control with no thermostats /on/off control), control with an analogue thermostat and control with a digital thermostat.

COLOR OPTIONS
RAL 7035 LIGHT GREY RAL 9005 BLACK

XX= Color Code, 02 means Light Grey RAL 7035 and 01 means Black RAL 9005, the code is added by the customer at the order.

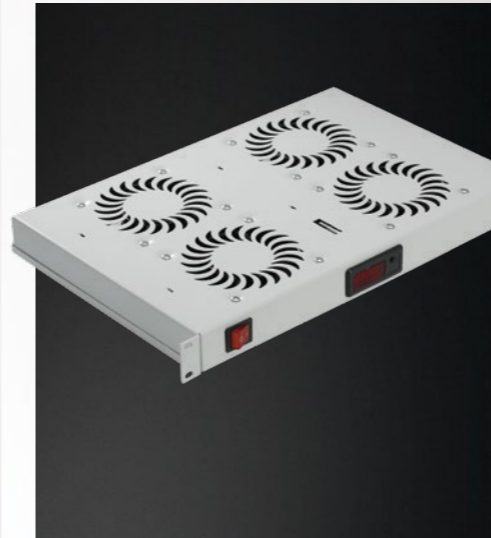

GT SERIES 19" SIDE BRACKET APPARATUS



Side brackets ; are the most frequently used accessories within GT series cabinets. They distribute the load to the vertical profiles in a balanced manner and 19" equipments may be attached between them when they are installed one under the other with 10U spacing.

They may be attached throughout the depth of the cabinet between two vertical profiles.

Numbers of the pieces provided with the standard cabinet configurations may be increased on order or later during installation.

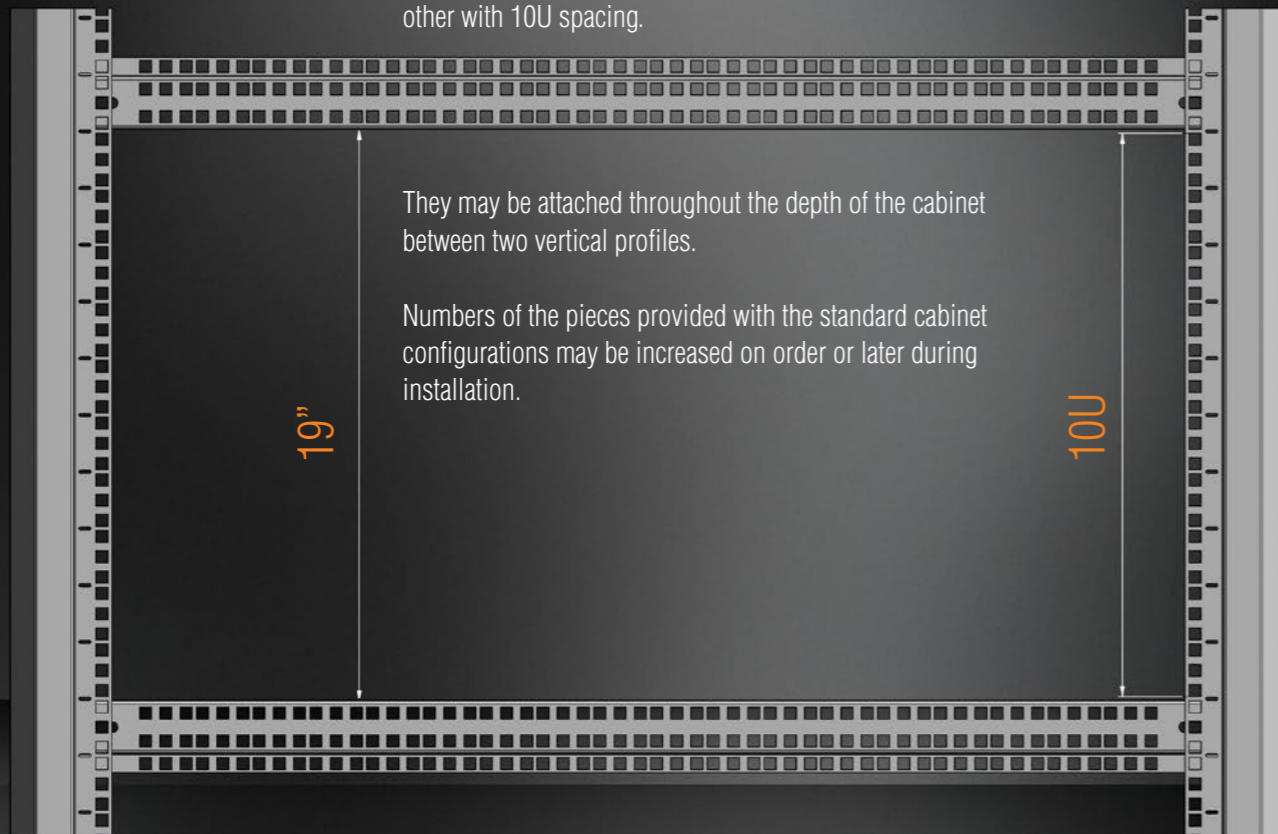

By means of readily present side brackets on the cabinet or by means of the ones added afterwards, any device of desired U value may be attached vertically, easily at the sides of the cabinet.

HORIZONTAL SUPPORT BARS

Product Code	Product Description	Product Dimensions WxDxH (mm)	Package Dimensions WxDxH (mm)	Product Net Weight (kg)	Product Gross Weight (kg)	Number in the Package (pcs)	Box Dimensions WxDxH (mm)	Box Gross Weight (kg)
MR.YNK60.ZN	D=600 horizontal support bar, galvanized	512x56x21	520x65x30	0,45	0,55	50	550x430x400	28,5
MR.YNK80.ZN	D=800 horizontal support bar, galvanized	702x56x21	710x65x30	0,6	0,7	50	810x430x525	36
MR.YNK100.ZN	D=1000 horizontal support bar, galvanized	902x56x21	910x65x30	0,8	0,9	1	910x65x30	0,9

Dimensions of the side bracket should chosen so as to be equal with the depth of the cabinet.

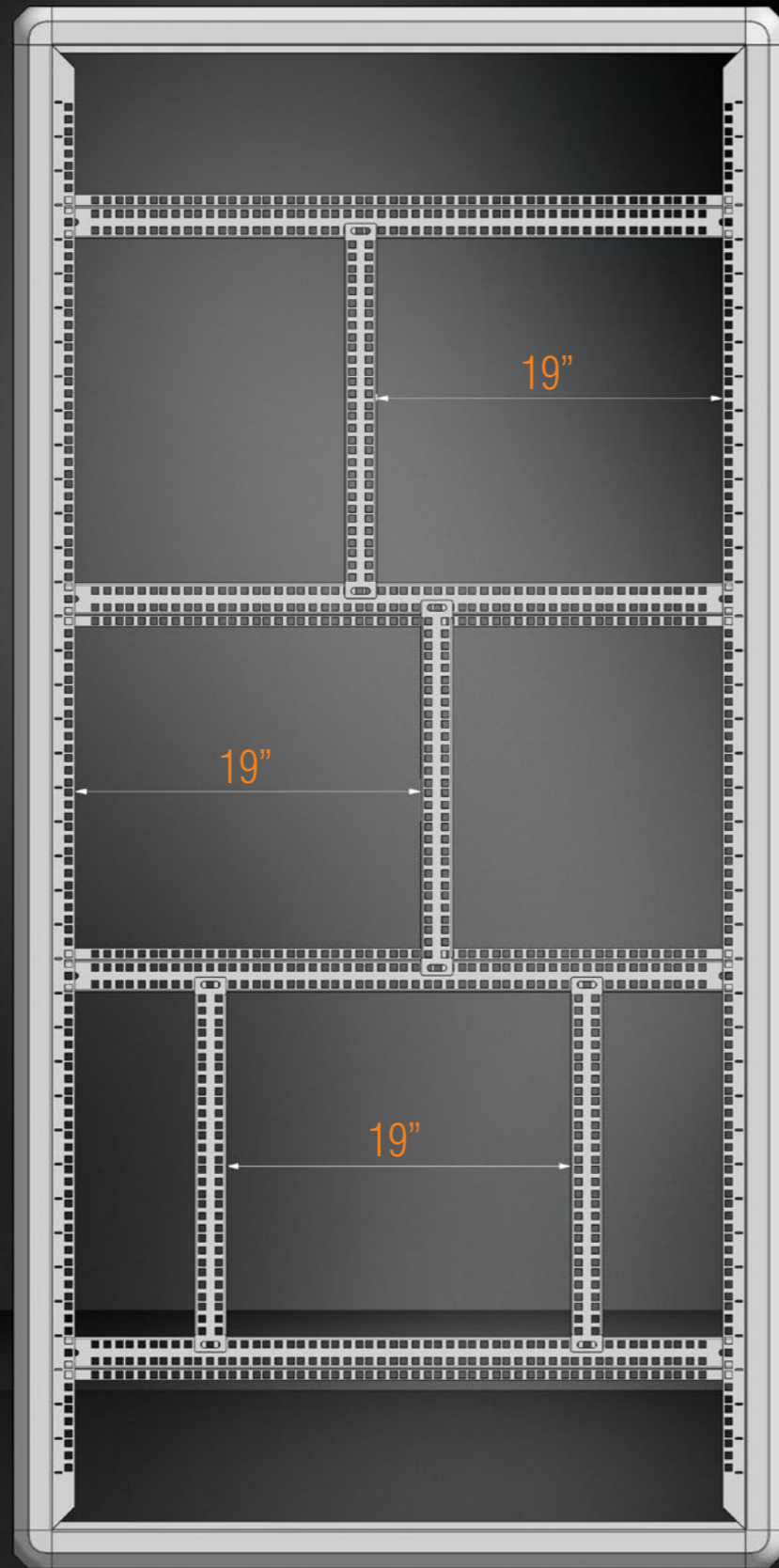
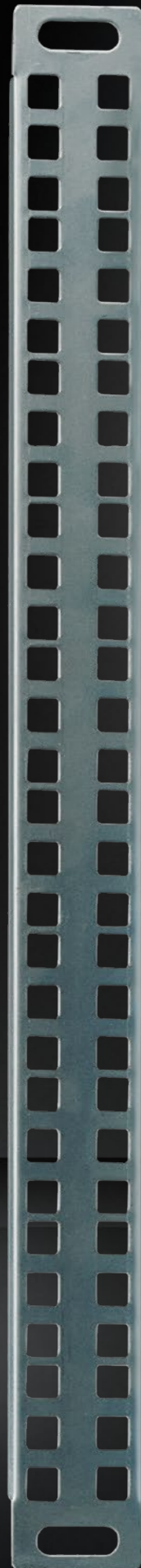

19" HORIZONTAL INSTALLATION

Side rails are accessories for D=800 and D=1000 GT Series cabinet, between the side brackets of which may be attached 19" equipments of max. 10U, horizontally.

Vertical profiles may be installed so as to establish 19" distance between them, as well as side by side by keeping again 19" distance.

SINGLE UTILIZATION

When the depths of the devices or equipments to be attached to the sides of the cabinets are low (fan module, patch panel etc.), 1 piece of side rail may be used with front or rear vertical profile.

DUAL UTILIZATION

When the depths of the devices or equipments to be attached to the sides of the cabinets are high (such as the rack with 4 points), 2 pieces of side rails may be used at the side of the cabinet, centralized, so as to keep 451 mm distance between them.

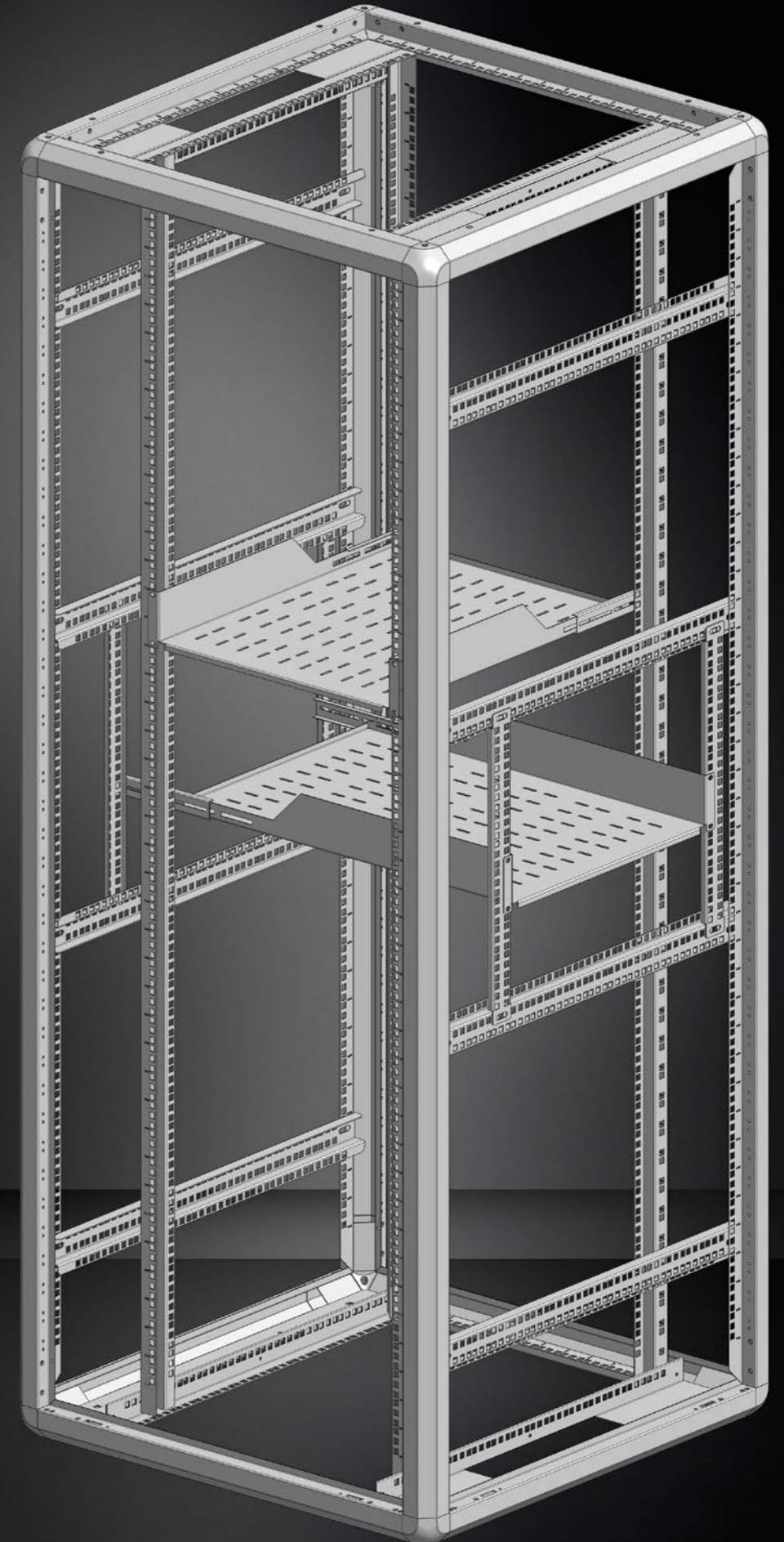

HORIZONTAL RAILS

Product Code	Product Description	Product Dimensions WxDxH (mm)	Package Dimensions WxDxH (mm)	Product Net Weight (kg)	Product Gross Weight (kg)	Number in the Package (pcs)	Box Dimensions WxDxH (mm)	Box Gross Weight (kg)
MR.YNCZN	horizontal mounting rail, galvanized finish	487x10x41	490x15x50	0,25	0,3	40	560x425x122	14

